

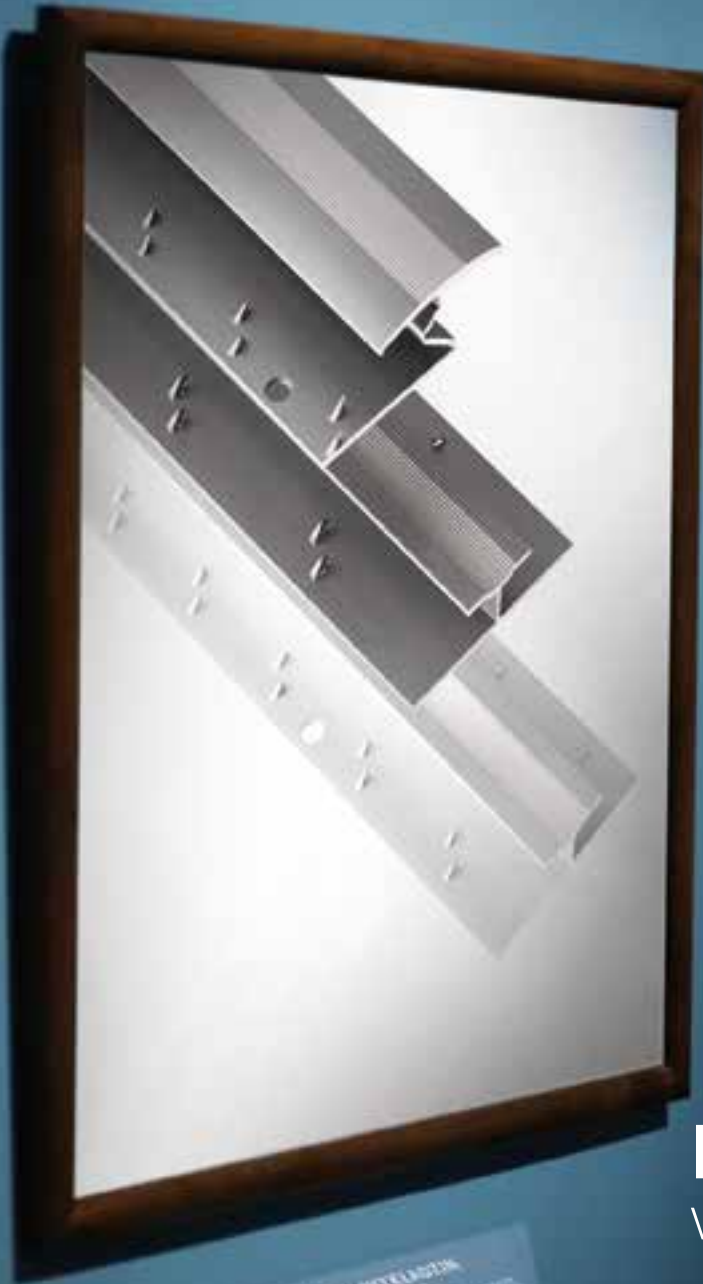

**EFFECTOR**



LISTWY DO WITELASZKI  
I STRANICH  
DŁUGOŚĆ 2000MM, SZEROKOŚĆ 20MM



LISTWA DO WITELASZKI  
I STRANICH  
DŁUGOŚĆ 2000MM, SZEROKOŚĆ 20MM



**Listwy**  
wykończeniowe  
i **elementy**  
aranżacji wnętrz

**Finishing** strips  
and elements  
of interior design

# SPIS TREŚCI

TABLE OF CONTENTS | INHALTSÜBERSICHT

8

## STANDARD – LISTWY WYKOŃCZENIOWE

FINISHING STRIPS | ABSCHUßLEISTEN

12

listwy łączeniowe  
joining strips | Übergangleisten

18

listwy dylatacyjne  
dilatation strips | Dehnungsleisten

20

kątowniki  
angle bars | Winkelprofile

26

listwy wykończeniowe  
finishing strips | Abschußleisten

28

## LISTWY DO PANELI WINYLOWYCH LVT

STRIPS FOR LVT FLOORS | LEISTEN FÜR LVT-BÖDEN

34

## LISTWY COKOŁOWE

SKIRTING BOARDS | SOCKELLEISTEN

42

## IMPRESJA – LISTWY DO GLAZURY I TERAKOTY

STRIPS FOR TILES | FLIESENLEISTEN

52

## STEEL – LISTWY ZE STALI NIERDZEWNEJ

STAINLESS STEEL STRIPS | EDELSTAHL LEISTEN

58

## BOA – LISTWY WYKOŃCZENIOWE GIĘTE

BENDABLE FINISHING STRIPS | BIEGELEISTEN

64

## EASY – KSZTAŁTOWNIKI DLA MAJSTERKOWICZÓW

DIY PROFILES | BASTLERPROFILE

72

## FANTAZJA – LISTWY BUDOWLANE PVC

BUILDING PVC STRIPS | DIE KUNSTOFFBAUPLEISTEN

# PIKTOGRAMY

PICTOGRAMS | PIKTOGRAMME

**AI**

## LISTWA ALUMINIOWA

Aluminium strip  
Aluminiumleiste

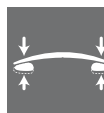

## LISTWA Z USZCZELKĄ SILIKONOWĄ

Strip with silicone gasket  
Leiste mit Silikondichtung

**S**

## LISTWY ZE STALI NIERDZEWNEJ

Stainless steel strips  
Edelstahl Leisten



## LISTWA LAKIEROWANA

Lacquered strip  
Lackierte Leiste

**PVC**

## LISTWA Z PVC

PVC strip  
Leisten aus PVC



## LISTWA PRZYKRĘCANA

Screwed strip  
Leiste angeschraubte

**ANODA**

## LISTWA Z POWŁOKĄ ANODOWANĄ

Strip with anodized coating  
Leiste mit Aluminiumschicht



## LISTWA SAMOPRZYLEPNA

Self-adhesive strip  
Leiste selbstklebend



## LISTWA OKLEINOWANA

Laminated strip  
Leiste mit Furnier



## LISTWA SZYBKIEGO MONTAŻU

Quick instalation strip  
Leiste, easy fix

**+**

## LISTWA ELEKTROPOLEROWANA

Electropolished strip  
Elektropolierte leiste



## LISTWA WYKOŃCZENIOWA GIĘTA

Finishing bendable strip  
Biegeleisten



## LISTWA Z ZACZEPAMI DO WYKŁADZIN I DYWANÓW

Strip with fastenings to floor coverings and carpets  
Leiste mit Haken zu den Bodenbelägen und den Teppichen

\*

**ZAM**

## PRODUKT DOSTĘPNY NA ZAMÓWIENIE

(ilości ustalane indywidualnie)

Product available on request  
Nur auf Bestellung

**WOOD  
-LOOK**

## WOOD-LOOK

The product is available in Wood-Look colors  
Das Produkt ist in Wood-Look erhältlich

# O NAS

Effector S.A. działa w branży budowlanej od trzydziestu lat, nieustannie pasjonując się możliwościami, które daje zaawansowana technologia w połączeniu z właściwościami aluminium i innych materiałów, służących do dekoracji wnętrz.

Swoją pozycję zawdzięczamy przede wszystkim inwestycjom w innowacyjne technologie, chroniące środowisko naturalne oraz nieustannemu doskonaleniu jakości produktów.

Nasze kolekcje profili wykończeniowych z aluminium oraz PVC to doskonałe rozwiązania, umożliwiające estetyczne, a zarazem funkcjonalne wykończenie podłóg laminowanych, drewnianych, wykonanych z glazury, terakoty, wykładziny oraz innych materiałów. Listwy wyróżniają się różnorodnością sposobów montażu, dostępnością dodatkowych akcesoriów, bogactwem kolorystyki aluminium anodowanego i oklein drewnopodobnych.



# ABOUT US



Effector S.A. has been active in the construction industry for thirty years, constantly passionate about the possibilities offered by advanced technology combined with the properties of aluminium and other materials used for interior decoration.

We owe our position primarily to investments in innovative technologies that protect the natural environment as well as continuous improvement of product quality.

Our collections of aluminium and PVC finishing strips are the perfect solutions for an aesthetic and functional finish of laminated or wooden floors, as well as those made of ceramic tiles, gres, covered with carpets and other materials. The strips are distinguished by a variety of installation methods, the availability of additional accessories, a rich colour range of anodized aluminium and wood-like veneers.



# EKOLOGIA

W Effector S.A. dbamy o każdy, najdrobniejszy szczegół podczas powstawania listew wykończeniowych, bo to jeden z istotnych detali, decydujący o charakterze każdego pomieszczenia. W centrum naszych zainteresowań jest człowiek, a jego potrzeby i wartości wyznaczają kierunki rozwoju naszej marki.

Dlatego właśnie tak duże znaczenie przywiązujemy do ekologii i optymalizujemy nasze procesy produkcyjne oraz redukujemy wpływ na środowisko. Stosujemy Zintegrowany System Zarządzania, obejmujący system zarządzania Jakością i Środowiskiem z serii ISO 9001 / ISO 14001.

Konsekwentnie wyznaczamy sobie coraz to nowe cele i dążymy do ich osiągnięcia. Nasze zadania to m.in. właściwe zarządzanie energią, segregacja odpadów, dbanie o czystość powietrza atmosferycznego.

Prowadzimy także kampanie informacyjne zachęcające do świadomych, proekologicznych zachowań, takich jak zrównoważony rozwój i podejmowanie działań w celu minimalizowania własnego wpływu na środowisko naturalne.



# ECOLOGY



In Effector S.A. we take care of every smallest detail when creating the finishing strips, because it is one of the important elements that determines the character of each room. People are at the center of our interests, and their needs and values set the directions for the development of our brand.

That is why we attach so much importance to ecology, optimize our production processes and reduce the impact on the environment. We use the Integrated Management System, including the ISO 9001 / ISO 14001 series of quality and environmental protection management.

We consistently set new goals and strive to achieve them. Our tasks include i.a. proper energy management, waste segregation, taking care of clean atmospheric air.

We also run information campaigns encouraging conscious, pro-ecological behaviours, such as sustainable development and taking actions to minimize our own impact on the natural environment.



# Listwy wykończeniowe





# Finishing strips

# STANDARD

listwy łączeniowe  
joining strips

listwy dylatacyjne  
dilatation strips

kątowniki  
angle bars

listwy wykończeniowe  
finishing strips

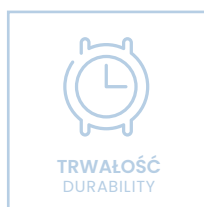

# ALUMINIUM ANODOWANE

ANODISED ALUMINIUM | ALUMINIUM ELOXIERT



01

**SREBRO**  
SILVER  
SILBER



71

**INOX GŁADKI**  
INOX SMOOTH  
INOX GLATT



07

**INOX SZCZOTKOWANY**  
BRUSHED INOX  
GEBÜRSTET INOX

ZAM



00

**ZŁOTO**  
GOLD  
GOLD



002

**ZŁOTO PIASKOWE**  
GOLD SAND  
SANDGOLD

ZAM



02

**SZAMPAN**  
CHAMPAGNE  
CHAMPAGNE



04

**OLIWKA**  
OLIVE  
OLIVE

ZAM

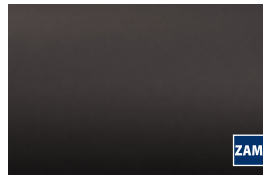

03

**BRAZ**  
BROWN  
BRAUN

ZAM



005

**CZARNY**  
BLACK  
SCHWARZ

ZAM

# ALUMINIUM OKLEINOWANE

VENEERED ALUMINIUM | ALUMINIUM UMMANTELT



28

**BUK JASNY**  
LIGHT BEECH  
BUCHE HELL



08

**BUK**  
BEECH  
BUCHE



WOOD-LOOK

20916

**DĄB BIAŁY**  
RAW OAK  
EICHE WEIß



20901

**DĄB BIELONY**  
WHITE OAK  
EICHE GEBLEICHT



WOOD-LOOK

20918

**DĄB BERGERAC**  
BERGERAC OAK  
EICHE BERGERAC



WOOD-LOOK

20917

**DĄB JAŚMINOWY**  
JASMINE OAK  
EICHE JASMIN



20915

**DĄB WANILIA**  
VANILLA OAK  
EICHE VANILLE



20913

**DĄB MALAGA**  
MALAGA OAK  
EICHE MALAGA



WOOD-LOOK

20919

**DĄB SZARY**  
GRAY OAK  
EICHE GRAUE



20902

**DĄB MOCCA**  
MOCCA OAK  
EICHE MOCCA



20912

**DĄB TABACCO**  
TABACCO OAK  
EICHE TABACCO



20904

**DĄB ARCTIC**  
ARCTIC OAK  
EICHE ARCTIC

## ALUMINIUM OKLEINOWANE

VENEERED ALUMINIUM | ALUMINIUM UMMANTELT



**20930** DĄB HELSINKI  
OAK HELSINKI  
HELSINKI-EICHE



**20927** DĄB TOKIO  
OAK TOKYO  
TOKIO-EICHE



**20926** DĄB NAIROBI  
OAK NAIROBI  
NAIROBI-EICHE



**20929** DĄB OSLO  
OAK OSLO  
OSLO-EICHE



**20928** DĄB RIO  
OAK RIO  
RIO-EICHE



**20920** DĄB NATURALNY  
NATURAL OAK  
EICHE NATUR



**20921** DĄB LEMON  
LEMON OAK  
EICHE LEMON



**20908** DĄB PIWNY  
BEER OAK  
EICHE HELLBRAUN



**29** DĄB JASNY  
LIGHT OAK  
EICHE HELL



**20907** DĄB PIĄSKOWY  
SANDY OAK  
EICHE SAND



**20906** DĄB KŃIAKOWY  
COGNAC OAK  
EICHE COGNAC



**20905** DĄB BURSZTYNOWY  
AMBER OAK  
EICHE BERNSTEIN



**20903** DĄB ANTYCZNY  
ANTIQUÉ OAK  
EICHE ANTIK



**20914** DĄB TOPAZ  
TOPAZ OAK  
EICHE TOPAS



**20911** DĄB VERDEN  
VERDEN OAK  
EICHE VERDEN



**20910** DĄB ZAMKOWY  
CASTLE OAK  
SCHLOSS EICHE



**0909** DĄB ŻŁOCIŚTY  
GOLDEN OAK  
EICHE GOLD



**09** DĄB  
OAK  
EICHE



NIE WYSTĘPUJE  
NOT AVAILABLE  
NICHT VERFÜGBAR

**E31, E33, E64, E66, E68**



**34** WIĄZ  
ELM  
ULME



**32** HIKORA  
HICKORY  
HIKORYBAUM



**20922** ORZECH SIENNA  
SIENNA NUT  
SIENNE NUSS



**2701** ORZECH CHILE  
CHILE NUT  
NUSSBAUM CHILE



**20944** MERBAU  
MERBAU  
MERBAU



**4500** TEAK INDYJSKI  
INDIAN TEAK  
INDISCHER TEAK



**33** AFREZJA  
AFREZY  
AFREZY



**3101** KASZTAN JAPONSKI  
JAPANESE CHESTNUT  
JAPANISCHE KASTANIE



**4201** WENGE KONGO  
CONGO WENGE  
WENGE KONGO

LISTWA ŁĄCZENIOWA

A02



JOINING STRIP  
ÜBERGANGSLEISTE

DŁUGOŚĆ [m] Length   Länge	0,93	1,2 *	1,8	2,7	3,6 *
-------------------------------	------	-------	-----	-----	-------

LISTWA ŁĄCZENIOWA

A03



JOINING STRIP  
ÜBERGANGSLEISTE

DŁUGOŚĆ [m] Length   Länge	0,93	1,2 *	1,8	2,7	3,6 *
-------------------------------	------	-------	-----	-----	-------

LISTWA ŁĄCZENIOWA

A04



JOINING STRIP  
ÜBERGANGSLEISTE

DŁUGOŚĆ [m] Length   Länge	0,93	1,2 *	1,8	2,7	3,6 *
-------------------------------	------	-------	-----	-----	-------

LISTWA ŁĄCZENIOWA

A08



JOINING STRIP  
ÜBERGANGSLEISTE

DŁUGOŚĆ [m] Length   Länge	0,93	1,2 *	1,8	2,7	3,6 *
-------------------------------	------	-------	-----	-----	-------

## LISTWA PROGOWA Z WKŁADKĄ ANTYPOŚLIZGOWĄ (GUMA)

SILL STRIP WITH ANTI-SLIP INSERT (RUBBER)  
SCHWELLENLEISTE MIT ANTI-RUTSCH EINSATZ (GUMMI)

DŁUGOŚĆ [m]  
Length | Länge

0,93

1,2\*

1,8

2,7

3,6\*

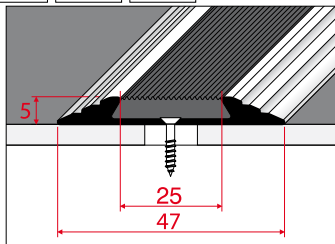
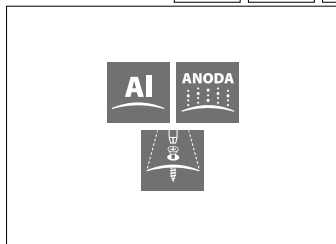

A10

## GUMA ANTYPOŚLIZGOWA DO LISTWY A10

NON-SLIP RUBBER A10  
ANTI-RUTSCH-GUMMI A10

KOLORY GUMY A10G  
RUBBER COLOURS  
FARBEN



88

CZARNY  
BLACK  
SCHWARZ



A10G

## LISTWA ŁĄCZENIOWA

JOINING STRIP  
ÜBERGANGSLEISTE

DŁUGOŚĆ [m]  
Length | Länge

0,93

1,8

2,7

3,6\*

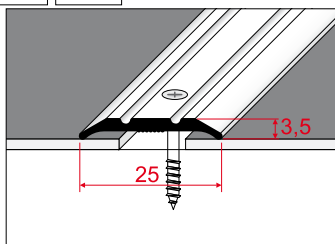
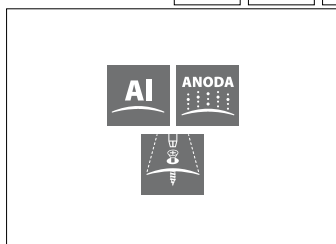

A12

## LISTWA ŁĄCZENIOWA

JOINING STRIP  
ÜBERGANGSLEISTE

DŁUGOŚĆ [m]  
Length | Länge

0,93

1,8

2,7

3,6\*

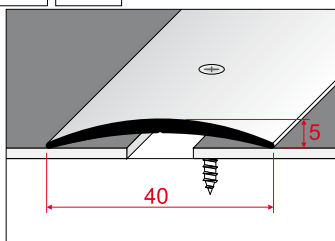
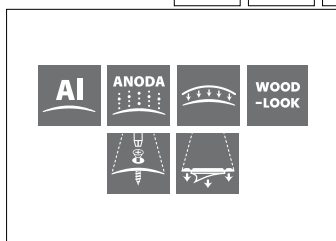

A13

LISTWA PROGOWA ŁĄCZENIOWA

A61

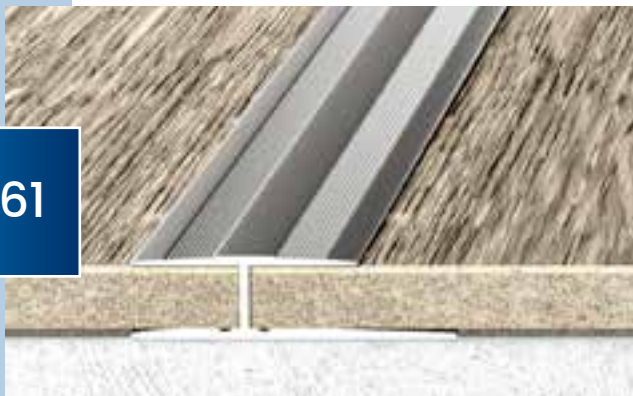

JOINING SILL STRIP  
ÜBERGANGSLEISTE

DŁUGOŚĆ [m] Length   Länge	0,9	1,2 *	1,8	2,7	3,6 *
-------------------------------	-----	-------	-----	-----	-------

LISTWA SZYBKIEGO MONTAŻU Z USZCZELKĄ SILIKONOWĄ

A64



QUICK-MOUNTED STRIP WITH SILICONE SEAL  
LEISTE MIT SILIKONDICHTUNG, EASY FIX

DŁUGOŚĆ [m] Length   Länge	0,93	1,2 *	1,8	2,7	3,6 *
-------------------------------	------	-------	-----	-----	-------

LISTWA SZYBKIEGO MONTAŻU Z USZCZELKĄ SILIKONOWĄ

A66



QUICK-MOUNTED STRIP WITH SILICONE SEAL  
LEISTE MIT SILIKONDICHTUNG, EASY FIX

DŁUGOŚĆ [m] Length   Länge	0,93	1,2 *	1,8	2,7	3,6 *
-------------------------------	------	-------	-----	-----	-------

LISTWA SZYBKIEGO MONTAŻU

A68



QUICK-MOUNTED STRIP  
LEISTE, EASY FIX

DŁUGOŚĆ [m] Length   Länge	0,9	1,2 *	1,8	2,7	3,6 *
-------------------------------	-----	-------	-----	-----	-------

LISTWA ZACISKOWA

CLAMPING STRIP  
KLEMMLEISTE

DŁUGOŚĆ [m]  
Length | Länge

0,9	1,2 *	1,8	2,7	3,6 *
-----	-------	-----	-----	-------

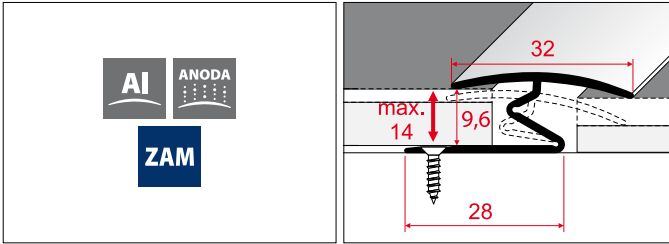

A69

LISTWA ŁĄCZENIOWA

JOINING STRIP  
ÜBERGANGSLEISTE

DŁUGOŚĆ [m]  
Length | Länge

1,0	2,0	3,0
-----	-----	-----

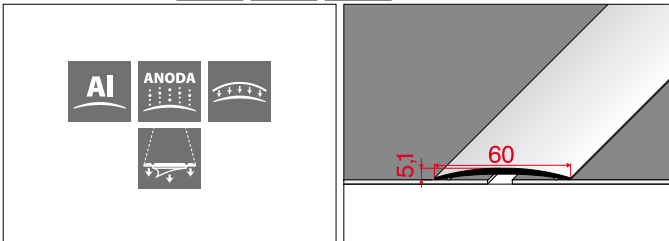

A70

LISTWA ŁĄCZENIOWA

JOINING STRIP  
ÜBERGANGSLEISTE

DŁUGOŚĆ [m]  
Length | Länge

1,0	2,0	3,0
-----	-----	-----

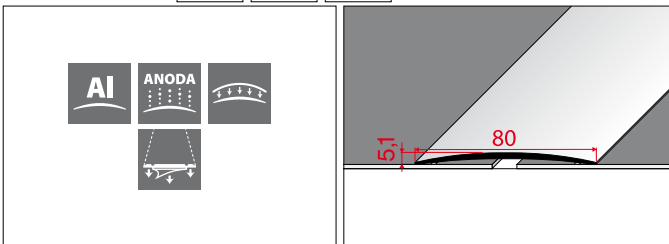

A71

LISTWA ŁĄCZENIOWA

JOINING STRIP  
ÜBERGANGSLEISTE

DŁUGOŚĆ [m]  
Length | Länge

1,0	2,0	3,0
-----	-----	-----

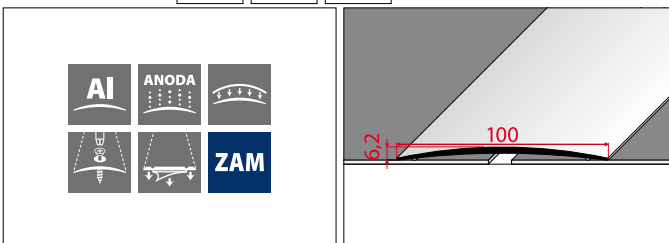

A72

LISTWA ŁĄCZENIOWA

A73



JOINING STRIP  
ÜBERGANGSLEISTE

DŁUGOŚĆ [m]  
Length | Länge

1,0	2,0	3,0
-----	-----	-----

LISTWA ŁĄCZENIOWA

A76



JOINING STRIP  
ÜBERGANGSLEISTE

DŁUGOŚĆ [m]  
Length | Länge

1,0
-----

LISTWA ŁĄCZENIOWA

A77



JOINING STRIP  
ÜBERGANGSLEISTE

DŁUGOŚĆ [m]  
Length | Länge

1,0
-----

LISTWA ŁĄCZENIOWA

C68



JOINING STRIP  
ÜBERGANGSLEISTE

DŁUGOŚĆ [m]  
Length | Länge

1,0	2,0	3,0
-----	-----	-----



LISTWA ZACISKOWA

CLAMPING STRIP  
KLEMMLEISTE

DŁUGOŚĆ [m]  
Length | Länge

1,0

2,0

3,0

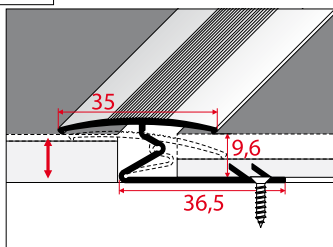
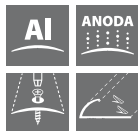

C69

LISTWA SZYBKIEGO MONTAŻU Z KLEJEM

QUICK-MOUNTED STRIP SELF-ADHESIVE  
LEISTE, EASY FIX SELBSTKLEBEND

DŁUGOŚĆ [m]  
Length | Länge

1,0

2,0

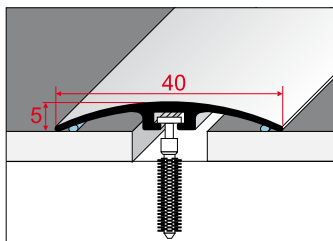

E64

LISTWA SZYBKIEGO MONTAŻU Z KLEJEM

QUICK-MOUNTED STRIP SELF-ADHESIVE  
LEISTE, EASY FIX SELBSTKLEBEND

DŁUGOŚĆ [m]  
Length | Länge

1,0

2,0

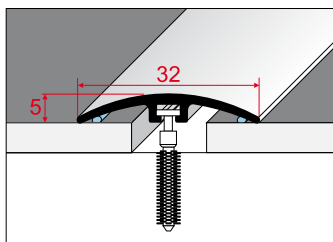

E66

LISTWA SZYBKIEGO MONTAŻU

QUICK-MOUNTED STRIP  
LEISTE, EASY FIX

DŁUGOŚĆ [m]  
Length | Länge

1,0

2,0

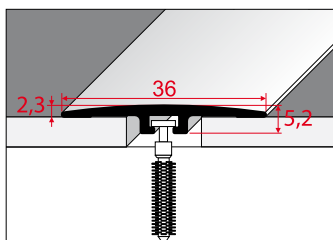

E68

LISTWA MOCUJĄCA ZAKOŃCZENIOWA

A11



EDGING STRIP  
ÜBERGANGSLEISTE SELBSTKLEBEND

DŁUGOŚĆ [m]  
Length | Länge

0,9 1,8 2,7 3,6 \*

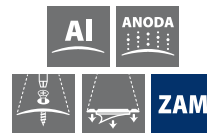
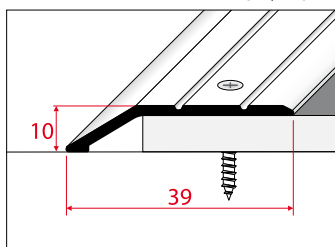

KAŹTOWNIK DYLATACYJNY 15 X 37

A39



DILATATION STRIP  
ABSCHLUSSLEISTE

DŁUGOŚĆ [m]  
Length | Länge

0,9 1,2 \* 1,8 2,7 3,6 \*

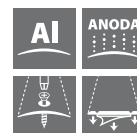
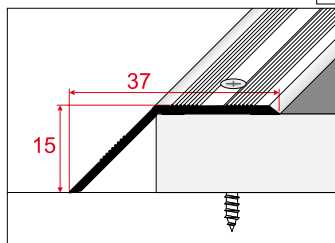

LISTWA DYLATACYJNA SAMOPRZYLEPNA

A47



DILATATION STRIP SELF-ADHESIVE  
DEHNUNGSLEISTE SELBSTKLEBEND

DŁUGOŚĆ [m]  
Length | Länge

0,9 1,2 \* 1,8 2,7 3,6 \*

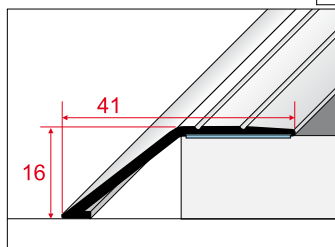

LISTWA NAJAZDOWA

A48



APPROACHING STRIP  
AUSGLEICHLEISTE

DŁUGOŚĆ [m]  
Length | Länge

1,0 2,0 3,0

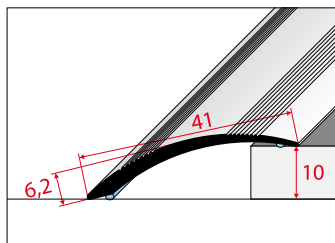

LISTWA NAJAZDOWA

APPROACHING STRIP  
AUSGLEICHSLEISTE

DŁUGOŚĆ [m]  
Length | Länge

1,0	2,0	3,0
-----	-----	-----

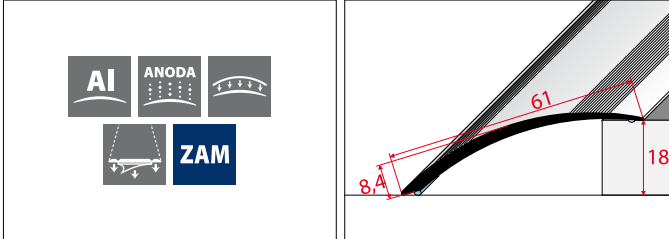

A49

LISTWA DYLATACYJNA

DILATION STRIP  
DEHNUNGSLEISTE

DŁUGOŚĆ [m]  
Length | Länge

0,9	1,2 *	1,8	2,7	3,6 *
-----	-------	-----	-----	-------

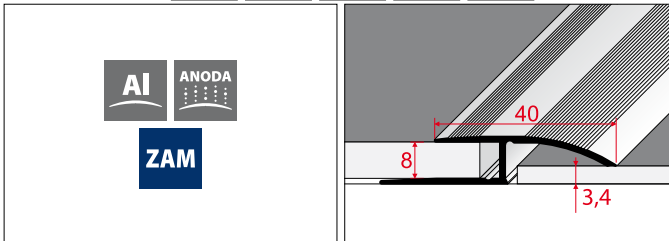

A62

LISTWA DYLATACYJNA SZYBKIEGO MONTAŻU Z USZCZELKĄ SILIKONOWĄ

QUICK-MOUNTED DILATION STRIP WITH SILICONE SEAL  
LEISTE MIT SILIKONDICHTUNG, EASY FIX

DŁUGOŚĆ [m]  
Length | Länge

0,93	1,2 *	1,8	2,7	3,6 *
------	-------	-----	-----	-------

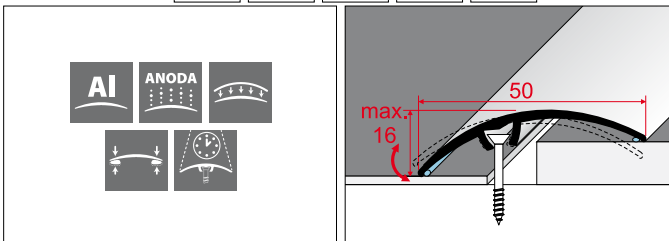

A65

LISTWA DYLATACYJNA SZYBKIEGO MONTAŻU Z USZCZELKĄ SILIKONOWĄ

QUICK-MOUNTED DILATION STRIP WITH SILICONE SEAL  
LEISTE MIT SILIKONDICHTUNG, EASY FIX

DŁUGOŚĆ [m]  
Length | Länge

0,93	1,2 *	1,8	2,7	3,6 *
------	-------	-----	-----	-------

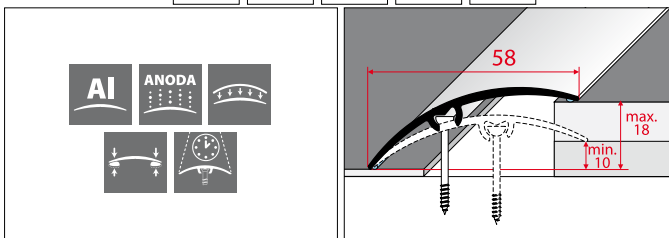

A75

**KĄTOWNIK 20 X 20**

**A30**



ANGLE BAR  
WINKELPROFIL

DŁUGOŚĆ [m] Length   Länge	0,9	1,2*	1,8	2,7	3,6*
-------------------------------	-----	------	-----	-----	------

**KĄTOWNIK 25 X 10**

**A31**



ANGLE BAR  
WINKELPROFIL

DŁUGOŚĆ [m] Length   Länge	0,9	1,2*	1,8	2,7	3,6*
-------------------------------	-----	------	-----	-----	------

**KĄTOWNIK 65 X 42**

**A32**



ANGLE BAR  
WINKELPROFIL

DŁUGOŚĆ [m] Length   Länge	0,9	1,2*	1,8	2,7	3,6*
-------------------------------	-----	------	-----	-----	------

**KĄTOWNIK 40 X 20**

**A33**



ANGLE BAR  
WINKELPROFIL

DŁUGOŚĆ [m] Length   Länge	0,9	1,2*	1,8	2,7	3,6*
-------------------------------	-----	------	-----	-----	------

KĄTOWNIK 35 X 35

ANGLE BAR  
WINKELPROFIL

DŁUGOŚĆ [m]  
Length | Länge

0,9	1,2 *	1,8	2,7	3,6 *
-----	-------	-----	-----	-------

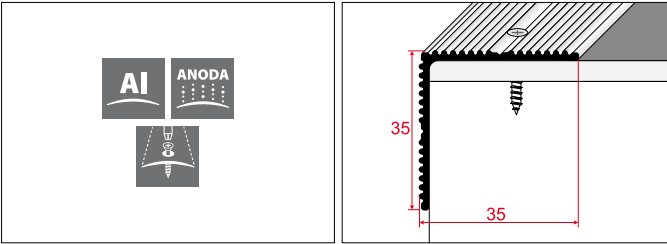

A34

KĄTOWNIK 20 X 20

ANGLE BAR  
WINKELPROFIL

DŁUGOŚĆ [m]  
Length | Länge

0,9	1,2 *	1,8	2,7	3,6 *
-----	-------	-----	-----	-------

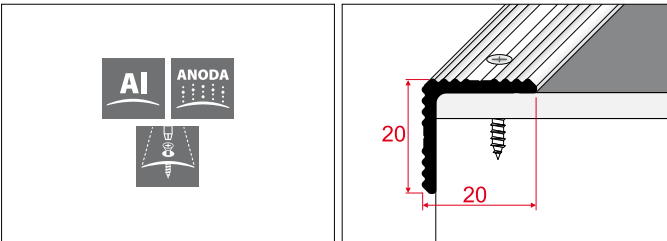

A35

KĄTOWNIK 25 X 20

ANGLE BAR  
WINKELPROFIL

DŁUGOŚĆ [m]  
Length | Länge

0,9	1,2 *	1,8	2,7	3,6 *
-----	-------	-----	-----	-------

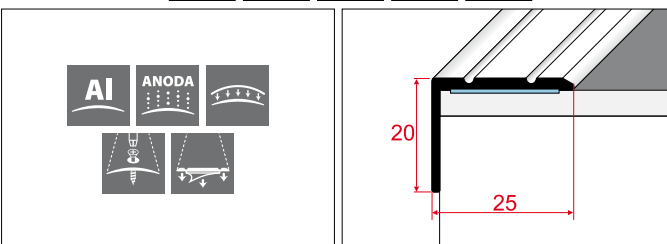

A36

KĄTOWNIK 25 X 25

ANGLE BAR  
WINKELPROFIL

DŁUGOŚĆ [m]  
Length | Länge

0,9	1,2 *	1,8	2,7	3,6 *
-----	-------	-----	-----	-------

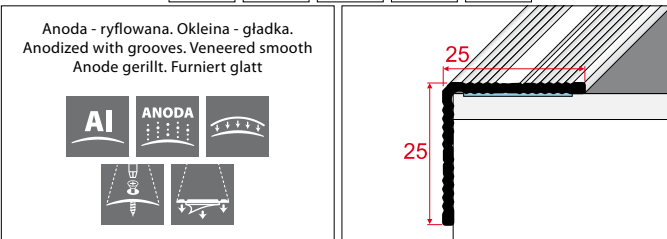

A40

**LISTWA SCHODOWA Z WKŁADKĄ ANTYPOŚLIZGOWĄ**

**A37**



STAIRS SLAT WITH ANTI-SLIP INSERT  
STUFENLEISTE MIT ANTI-RUTSCH-EINSATZ (GUMMI)

DŁUGOŚĆ [m]  
Length | Länge

0,9	1,2*	1,8	2,7	3,6*
-----	------	-----	-----	------

**GUMA ANTYPOŚLIZGOWA DO LISTWY A37**

**A37G**



NON-SLIP RUBBER A37  
ANTI-RUTSCH-GUMMI A37

KOLORY GUMY A37G  
RUBBER COLOURS  
FARBEN

**88** CZARNY  
BLACK  
SCHWARZ

**LISTWA SCHODOWA Z WKŁADKĄ ANTYPOŚLIZGOWĄ**

**A38**



STAIRS SLAT WITH ANTI-SLIP INSERT  
STUFENLEISTE MIT ANTI-RUTSCH-EINSATZ (GUMMI)

DŁUGOŚĆ [m]  
Length | Länge

0,9	1,2*	1,8	2,7	3,6*
-----	------	-----	-----	------

**GUMA ANTYPOŚLIZGOWA DO LISTWY A38**

**A38G**



NON-SLIP RUBBER A38  
ANTI-RUTSCH-GUMMI A38

KOLORY GUMY A38G  
RUBBER COLOURS  
FARBEN

**88** CZARNY  
BLACK  
SCHWARZ

KĄTOWNIK 35 X 35

ANGLE BAR  
WINKELPROFIL

DŁUGOŚĆ [m]  
Length | Länge

0,9

1,2 \*

1,8

2,7

3,6 \*

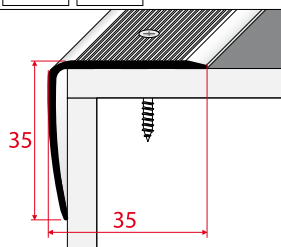
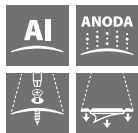

A41

KĄTOWNIK 41 X 26,6

ANGLE BAR  
WINKELPROFIL

DŁUGOŚĆ [m]  
Length | Länge

0,9

1,2 \*

1,8

2,7

3,6 \*

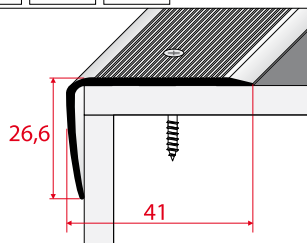
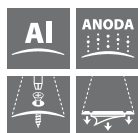

A42

KĄTOWNIK Z TAŚMĄ ANTYPOŚLIZGOWĄ

ANGLE BAR WITH ANTI-SKIDDING TAPE  
WINKELPROFIL MIT ANTI-RUTSCH-EINSATZ (BAND)

DŁUGOŚĆ [m]  
Length | Länge

0,9

1,2 \*

1,8

2,7

3,6 \*

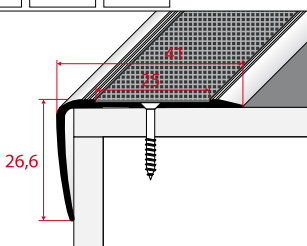

A44

KĄTOWNIK 20 X 8

ANGLE BAR  
WINKELPROFIL

DŁUGOŚĆ [m]  
Length | Länge

0,9

1,8

2,7

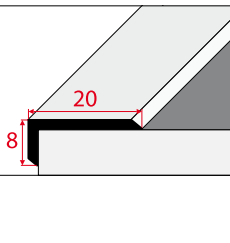

A46

**LISTWA SCHODOWA**

**A60**



ANGLE BAR  
WINKELPROFIL

DŁUGOŚĆ [m]  
Length | Länge

0,9

1,2\*

1,8

2,7

3,6\*

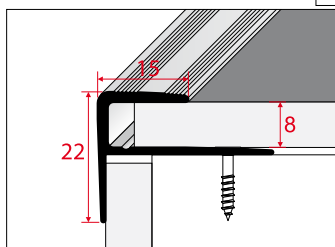

**KĄTOWNIK 25 X 10 SAMOPRZYLEPNY**

**E31**



ANGLE BAR SELF-ADHESIVE  
WINKELPROFIL SELBSTKLEBEND

DŁUGOŚĆ [m]  
Length | Länge

1,0

2,0

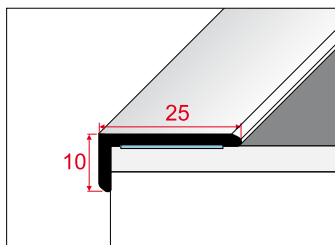

**KĄTOWNIK 35 X 20 SAMOPRZYLEPNY**

**E33**



ANGLE BAR SELF-ADHESIVE  
WINKELPROFIL SELBSTKLEBEND

DŁUGOŚĆ [m]  
Length | Länge

1,0

2,0

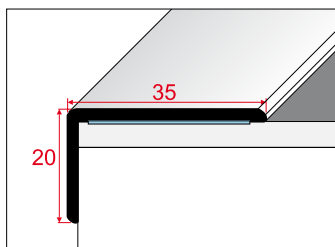





LISTWA MOCUJĄCA KRAWĘDZIE WYKŁADZIN

A01



FLOOR COVERING EDGE FIXING STRIP  
ABSCHLUSSLEISTE

DŁUGOŚĆ [m]  
Length | Länge

0,9 1,2\* 1,8 2,7 3,6\*

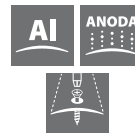
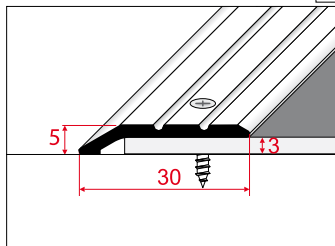

PRĘT SCHODOWY CHODNIKOWY Z UCHWYTEM MOCUJĄCYM

A06



STAIR FLOOR-CLOTH FASTENING BAR WITH MOUNTING HOLDER  
STUFENTEPPICHSTANGE MIT BEFESTIGUNG

DŁUGOŚĆ [m]  
Length | Länge

0,8 0,9 1,0 1,2\* 1,35\*

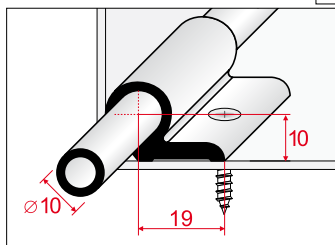

Pakowany po 3 szt.  
Packed by 3 pcs.  
Verpackungseinheit 3 Stck.

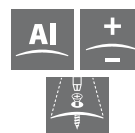

ZAKOŃCZENIE DO PRĘTÓW - KULKOWE

A06  
Z2



ENDS FOR BARS - BALL TYPE  
RUNDER ABSCHLUSS

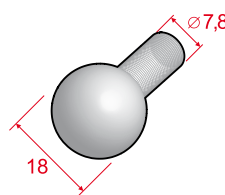

Pakowany po 2 szt.  
Packed by 2 pcs.  
Verpackungseinheit 2 Stck.



LISTWA ZAKOŃCZENIOWA

A63



EDGING STRIP  
ABSCHLUSSLEISTE

DŁUGOŚĆ [m]  
Length | Länge

0,9 1,2\* 1,8 2,7 3,6\*

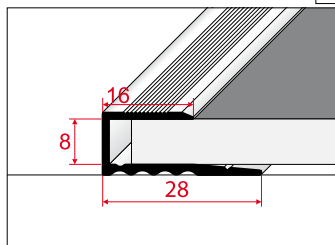

EDGE STRIP  
RANDELEISTE

DŁUGOŚĆ [m]  
Length | Länge

1,0

2,0

3,0

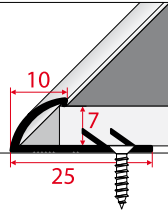
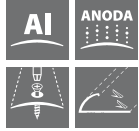

C07



A decorative interior scene featuring a light-colored wall with two framed abstract artworks. Below the art is a white surface holding a stack of books, a gold candle holder, and a vase with white flowers. In the foreground, a wooden cabinet with a herringbone pattern is visible. The text 'Listwy do paneli winylowych LVT' is overlaid on the bottom left of the image.

Listwy  
do paneli winylowych  
**LVT**

# Strips for LVT floors



BEZPIECZEŃSTWO  
SAFETY



TRWAŁOŚĆ  
DURABILITY



ELEGANCJA  
ELEGANCE



BEZ ZAWARTOŚCI  
OŁOWIU  
LEAD FREE



NOWOCZESNY  
DESIGN  
MODERN DESIGN



EKSPRESOWY  
MONTAŻ  
QUICK MOUNT



PRODUKT POLSKI  
POLISH PRODUCT



ODPORNOŚĆ  
NA ZARYSOWANIA  
SCRATCH RESISTANT



PRZYJAZNE  
ŚRODOWISKU  
ECO-FRIENDLY

# ALUMINIUM ANODOWANE

ANODISED ALUMINIUM | ALUMINIUM ELOXIERT

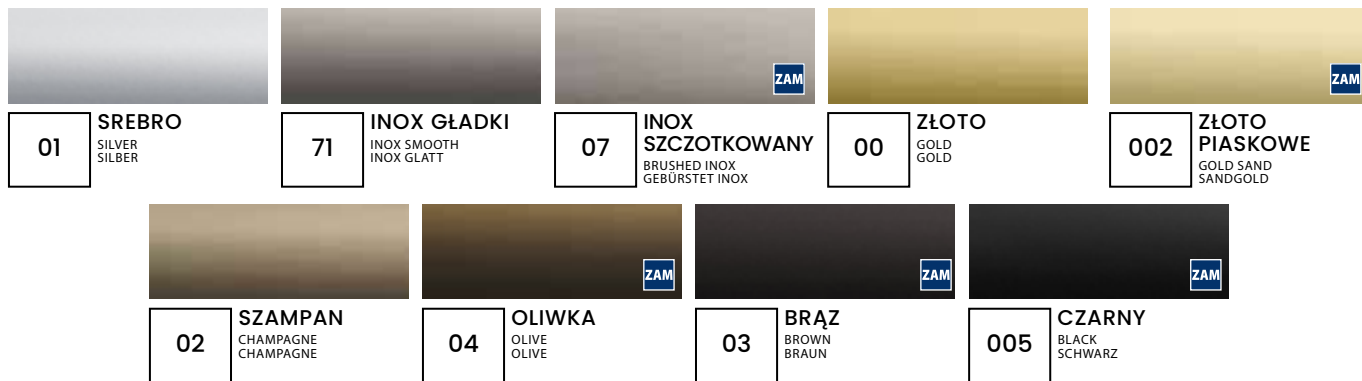

## LISTWA ZAKOŃCZENIOWA

C23

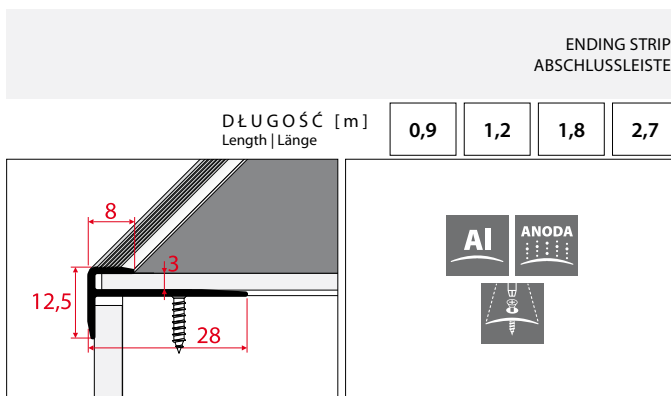

## LISTWA ZAKOŃCZENIOWA

C24

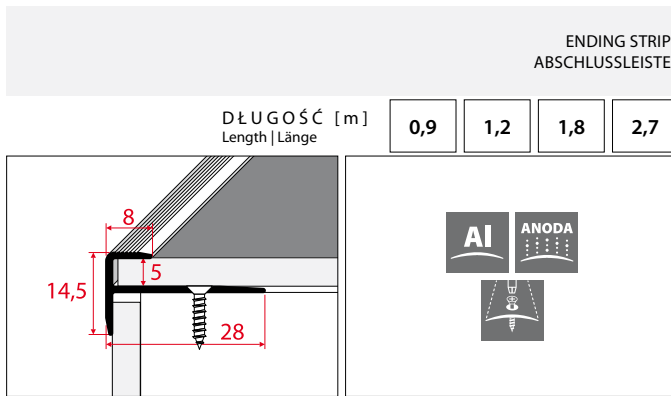

## LISTWA ZAKOŃCZENIOWA

C25

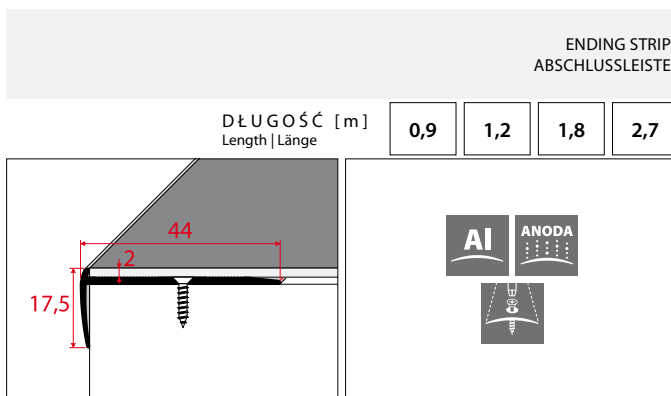

LISTWA ZAKOŃCZENIOWA

ENDING STRIP  
ABSCHLUSSLEISTE

DŁUGOŚĆ [m]  
Length | Länge

0,9	1,2	1,8	2,7
-----	-----	-----	-----

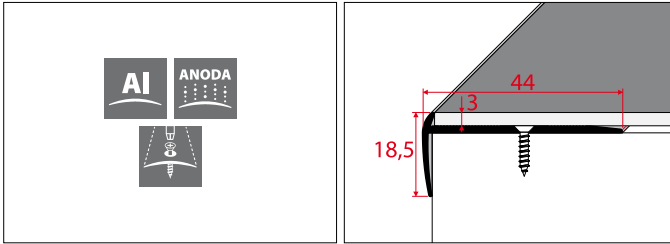

C26

LISTWA ZAKOŃCZENIOWA

ENDING STRIP  
ABSCHLUSSLEISTE

DŁUGOŚĆ [m]  
Length | Länge

0,9	1,2	1,8	2,7
-----	-----	-----	-----

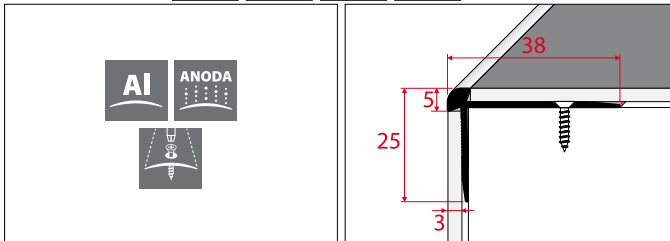

C28

LISTWA ZAKOŃCZENIOWA

ENDING STRIP  
ABSCHLUSSLEISTE

DŁUGOŚĆ [m]  
Length | Länge

0,9	1,2	1,8	2,7
-----	-----	-----	-----

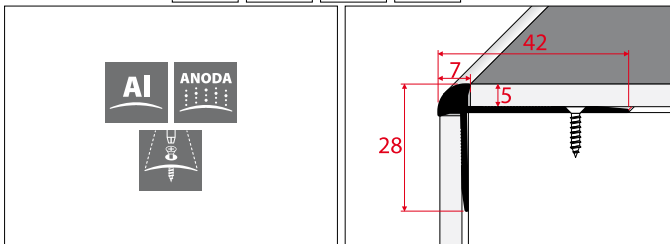

C29

LISTWA ZAKOŃCZENIOWA

ENDING STRIP  
ABSCHLUSSLEISTE

DŁUGOŚĆ [m]  
Length | Länge

0,9	1,2	1,8	2,7
-----	-----	-----	-----

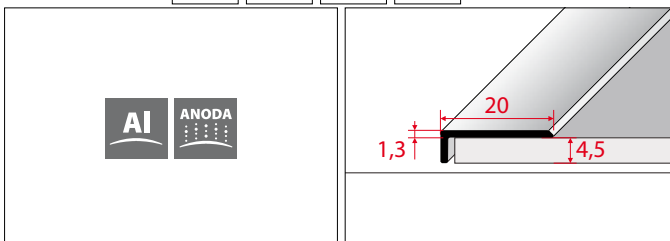

C33

LISTWA ZAKOŃCZENIOWA

C63



ENDING STRIP  
ABSCHLUSSLEISTE

DŁUGOŚĆ [m]  
Length | Länge

0,9

1,8

2,7

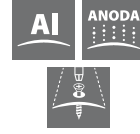
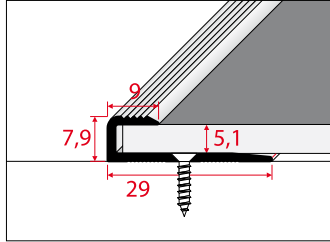

LISTWA DYLATACYJNA Z BAZĄ

C70



EXPANSION STRIP WITH BASE  
AUSCHLEICHLEISTE MIT BASIS

DŁUGOŚĆ [m]  
Length | Länge

1,0

2,7

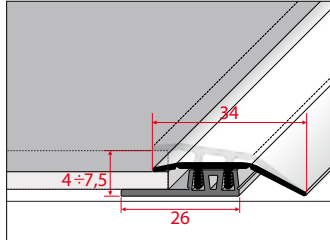

KOLOR  
Colour | Farbe  
**SREBRO**  
SILVER | SILBER



LISTWA ŁĄCZENIOWA Z BAZĄ

C71



CONNECTING STRIP WITH BASE  
ÜBERGANGSLEISTE MIT BASIS

DŁUGOŚĆ [m]  
Length | Länge

1,0

2,7

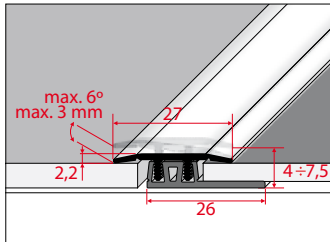

KOLOR  
Colour | Farbe  
**SREBRO**  
SILVER | SILBER



LISTWA ŁĄCZENIOWA Z BAZĄ

C72



CONNECTING STRIP WITH BASE  
ÜBERGANGSLEISTE MIT BASIS

DŁUGOŚĆ [m]  
Length | Länge

1,0

2,7

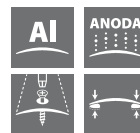
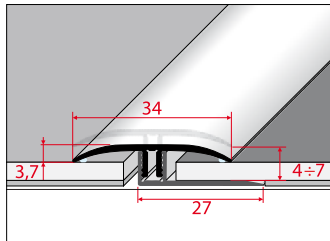



LISTWA ŁĄCZENIOWA

CONNECTING STRIP  
ÜBERGANGSLEISTE

DŁUGOŚĆ [m]  
Length | Länge **2,7**

KOLOR  
Colour | Farbe  
**SREBRO**  
SILVER | SILBER

AI  
ANODA



C76

LISTWA ZAKOŃCZENIOWA Z BAZĄ

ENDING STRIP WITH BASE  
AUSGLEICHSLEISTE MIT BASIS

DŁUGOŚĆ [m]  
Length | Länge **1,0** **2,7**

KOLOR  
Colour | Farbe  
**SREBRO**  
SILVER | SILBER

AI  
ANODA



C77

LISTWA DYLATACYJNA Z WKŁADKĄ EPDM

EXPANSION STRIP WITH EPDM INSERT  
AUSGLEICHSLEISTE MIT EPDM EINSATZ

DŁUGOŚĆ [m]  
Length | Länge **2,5**

	A	AI	KOLOR Colour   Farbe <b>SREBRO</b> SILVER   SILBER
<b>C78</b>	3		
<b>C79</b>	4,5		

KOLOR EPDM  
EPDM COLOUR | FARBEN **SZARY**  
GREY | GRAU

Minimalne zam. 10 szt.  
MOQ 10pcs  
Mindestbestellmenge 10 St.



C78-79

LISTWA DYLATACYJNA ZE STALI NIERDZEWNEJ Z WKŁADKĄ EPDM

STAINLESS STEEL EXPANSION STRIP WITH EPDM INSERT  
EDELSTAHLAUSGLEICHSLEISTE MIT EPDM EINSATZ

DŁUGOŚĆ [m]  
Length | Länge **2,5**

	A	S
<b>NC80</b>	3	
<b>NC81</b>	4,5	

KOLOR EPDM  
EPDM COLOUR | FARBEN **SZARY**  
GREY | GRAU

Minimalne zam. 10 szt.  
MOQ 10pcs  
Mindestbestellmenge 10 St.



NC80-81

# Listwy cokółowe



**Skirting boards**



**BEZPIECZEŃSTWO**  
SAFETY

**TRWAŁOŚĆ**  
DURABILITY

**ELEGANCJA**  
ELEGANCE

**PRODUKT POLSKI**  
POLISH PRODUCT

**NOWOCZESNY**  
DESIGN  
MODERN DESIGN

**EKSPRESOWY**  
MONTAŻ  
QUICK MOUNT

**ODPORNOŚĆ**  
NA ZARYSOWANIA  
SCRATCH RESISTANT

**PRZYJAZNE**  
ŚRODOWISKU  
ECO-FRIENDLY

**BEZ ZAWARTOŚCI**  
OŁOWIU  
LEAD FREE

# KOLORYSTYKA Q63

COLOURING | FARBE

## ALUMINIUM ANODOWANE

ANODISED ALUMINIUM | ALUMINIUM ELOXIERT



### LISTWA COKOŁOWA ALUMINIOWA SAMOPRZYLEPNA

SKIRTING BOARD SELF-ADHESIVE  
SOCKELPROFIL SELBSTKLEBEND

DŁUGOŚĆ [m]  
Length | Länge

2,7

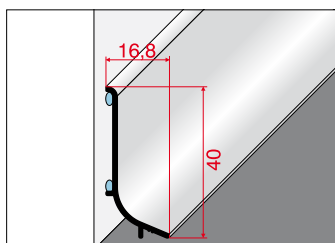

Q63

NAROŻNIK WEWNĘTRZNY Q63

Q63 - INTERNAL CORNER  
Q63 - INNENECKE

Pakowany po 2 szt.  
Packed by 2 pcs.  
Verpackungseinheit 2 Stck.

PVC

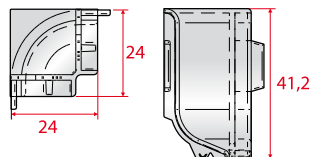

Q63

NAROŻNIK ZEWNĘTRZNY Q63

Q63 - EXTERNAL CORNER  
Q63 - AUSSENECKE

Pakowany po 2 szt.  
Packed by 2 pcs.  
Verpackungseinheit 2 Stck.

PVC

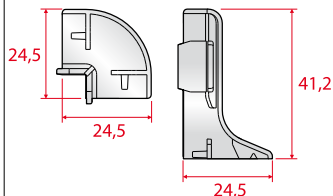

Q63

ŁĄCZNIK Q63

CONNECTOR  
ZWISCHENSTUECK

Pakowany po 2 szt.  
Packed by 2 pcs.  
Verpackungseinheit 2 Stck.

PVC

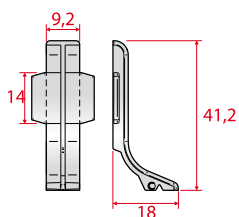

Q63

ZAKOŃCZENIE PRAWE I LEWE Q63

RIGHT AND LEFT ENDING  
ENDSTÜCK LINKS UND RECHTS

Pakowane po 2 szt.  
(kpl. zakończenie prawe i lewe)  
Packed by 2 pcs.  
(right and left ending profile)  
Verpackt je 2 Stck.  
(Endstück links oder rechts)

PVC

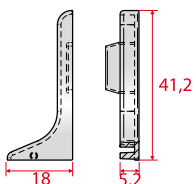

Q63

# KOLORYSTYKA EFFECTA

COLOURING | FARBE



EF001



EF002



EF003



EF004



EF005



EF006



EF007



EF008



EF009



EF010



EF011



EF012



EF013



EF014



EF015



EF016



EF017



EF018

## LISTWA PRZYPODŁOGOWA PVC

Effecta



PVC SKIRTING BOARD  
SOCKELLEISTE

DŁUGOŚĆ [m]  
Length | Länge

2,5

Pakowany po 27 szt.  
Packed by 27 pcs.  
Verpackungseinheit 27 Stck.

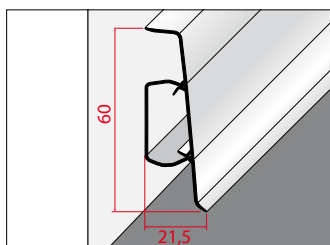

NAROŻNIK WEWNĘTRZNY

INTERNAL CORNER  
INNENECKE

Pakowany po 25 szt.  
Packed by 25 pcs.  
Verpackungseinheit 25 Stck.

PVC

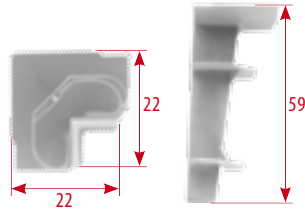

Effecta

NAROŻNIK ZEWNĘTRZNY

EXTERNAL CORNER  
AUSSENECKE

Pakowany po 25 szt.  
Packed by 25 pcs.  
Verpackungseinheit 25 Stck.

PVC

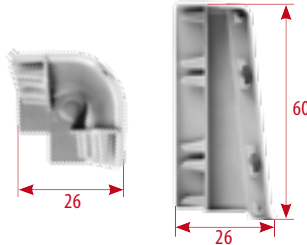

Effecta

ŁĄCZNIK

CONNECTOR  
ZWISCHENSTÜCK

Pakowany po 25 szt.  
Packed by 25 pcs.  
Verpackungseinheit 25 Stck.

PVC

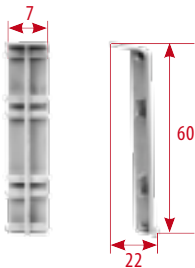

Effecta

ZAKOŃCZENIE PRAWE I LEWE

RIGHT AND LEFT ENDING  
ENDSTÜCK LINKS UND RECHTS

Pakowane po 25 szt.  
(kpl. zakończenie prawe i lewe)  
Packed by 25 pcs.  
(right and left ending profile)  
Verpackt je 25 Stck. oder Sätze  
(Endstück links oder rechts)

PVC

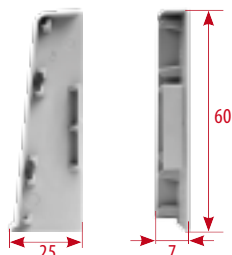

Effecta

# KOLORYSTYKA CLASSIC

COLOURING | FARBE



CL001



CL002



CL003



CL004



CL005



CL006

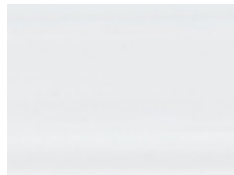

CL007



CL008



CL009



CL010



CL011



CL012



CL013



CL014



CL015



CL016



CL017



CL018



CL019

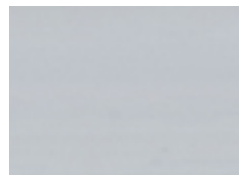

CL020

## LISTWA PRZYPODŁOGOWA PVC

Classic

PVC SKIRTING BOARD  
SOCKELLEISTE

DŁUGOŚĆ [m]  
Length | Länge

2,5

Pakowany po 40 szt.  
Packed by 40 pcs.  
Verpackungseinheit 40 Stck.

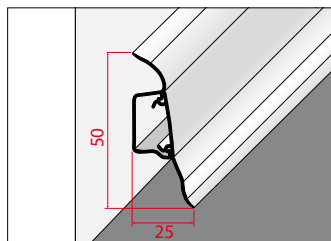



NAROŻNIK WEWNĘTRZNY

INTERNAL CORNER  
INNENECKE

Pakowany po 25 szt.  
Packed by 25 pcs.  
Verpackungseinheit 25 Stck.

PVC

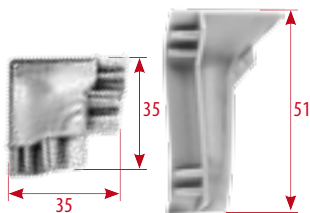

Classic

NAROŻNIK ZEWNĘTRZNY

EXTERNAL CORNER  
AUSSENECKE

Pakowany po 25 szt.  
Packed by 25 pcs.  
Verpackungseinheit 25 Stck.

PVC

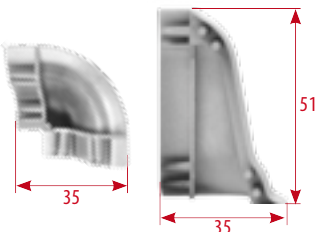

Classic

ŁĄCZNIK

CONNECTOR  
ZWISCHENSTÜCK

Pakowany po 25 szt.  
Packed by 25 pcs.  
Verpackungseinheit 25 Stck.

PVC

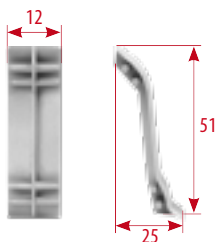

Classic

ZAKOŃCZENIE PRAWE I LEWE

RIGHT AND LEFT ENDING  
ENDSTÜCK LINKS UND RECHTS

Pakowane po 25 szt.  
(kpl. zakończenie prawe i lewe)  
Packed by 25 pcs.  
(right and left ending profile)  
Verpackt je 25 Stck. oder Sätze  
(Endstück links oder rechts)

PVC

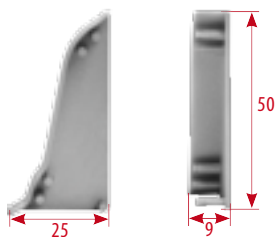

Classic

# Listwy — do glazury i terakoty



# IMPRESJA

Stripes for tiles

## LISTWY PAKOWANE PO 5 SZT.

STRIPS PACKED BY 5 PIECES.  
LEISTEN VERPACKT ZU JE 5 STK



BEZPIECZEŃSTWO  
SAFETY



TRWAŁOŚĆ  
DURABILITY



ELEGANCJA  
ELEGANCE



BOGATA GAMA  
KOLORYSTYCZNA  
COLORFUL



NOWOCZESNY  
DESIGN  
MODERN DESIGN



EKSPRESOWY  
MONTAŻ  
QUICK MOUNT



PRODUKT POLSKI  
POLISH PRODUCT



ODPORNOŚĆ  
NA ZARYSOWANIA  
SCRATCH RESISTANT



PRZYJAZNE  
ŚRODOWISKU  
ECO-FRIENDLY



BEZ ZAWARTOŚCI  
OŁOWIU  
LEAD FREE

# ALUMINIUM ANODOWANE

ANODISED ALUMINIUM | ALUMINIUM ELOXIERT



**01** SREBRO  
SILVER  
SILBER



**71** INOX GŁADKI  
INOX SMOOTH  
INOX GLATT



**07** INOX SZCZOTKOWANY  
BRUSHED INOX  
GEBÜRSTET INOX



**00** ZŁOTO  
GOLD  
GOLD



**002** ZŁOTO PIASKOWE  
GOLD SAND  
SANDGOLD



**02** SZAMPAN  
CHAMPAGNE  
CHAMPAGNE



**04** OLIWKA  
OLIVE  
OLIVE



**03** BRĄZ  
BROWN  
BRAUN



**005** CZARNY  
BLACK  
SCHWARZ



**E01** ELEKTROPOLER  
SREBRO  
ELECTROPOLISHED SILVER  
ELECTROPOLIERT SILBER

# ALUMINIUM NATURALNE

NATURAL ALUMINIUM | NATUR ALUMINIUM

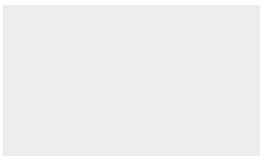

**90** NATURALNE  
NATURAL  
NATUR



**91** POLEROWANE  
POLISHED  
POLIERT, GLÄNZEND



**E00** ELEKTROPOLER  
ZŁOTO  
ELECTROPOLISHED GOLD  
ELECTROPOLIERT GOLD

# ALUMINIUM LAKIEROWANE

LACQUERED ALUMINIUM | LACKIERTES ALUMINIUM



**9016** BIAŁY  
WHITE  
WEISS



**7016** GRAFIT  
GRAPHITE  
GRAPHIT

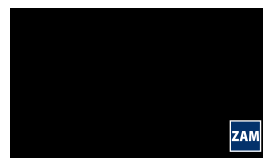

**9005** CZARNY  
BLACK  
SCHWARZ

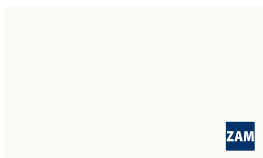

**0012** ŚNIEŻNA  
BIEL  
SNOW WHITE  
SCHNEEWEISS



**0017** KWARCOWY  
BŁYSK  
QUARTZ FLASH  
QUARZ BLITZ



**0014** BEŻOWE  
LŚNIENIE  
BEIGE GLITTER  
BEIGE GLANZ



**0016** KSIĘŻYCOWY  
BLĄSK  
LUNAR GLOW  
MONDSCHEN



**0010** METALICZNY  
POŁYSK  
METALLIC GLOSS  
METALLIC GLANZ

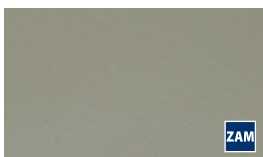

**0018** KAMIENNA  
SZAROŚĆ  
STONE GRAY  
STEINGRAU



**0019** LODOWA  
SZAROŚĆ  
ICE GRAY  
EISGRAU



**0011** METALICZNA  
SZAROŚĆ  
METALLIC GRAY  
METALLIC GRAU



**0013** ZIEMISTE  
ZŁOTO  
EARTHY GOLD  
ERDIGES GOLD



**0015** CZARNA  
ZIEMIA  
BLACK EARTH  
SCHWARZE ERDE

LISTWA KRAWĘDZIOWA

EDGE STRIP  
RANDLEISTE

DŁUGOŚĆ [m]  
Length | Länge

1,0	2,0	2,5	3,0
-----	-----	-----	-----

	A
A50	8
A51	10
A52	12

AI  
ANODA  
+  
-



A50-52

LISTWA KRAWĘDZIOWA OWALNY

OVAL EDGE STRIP  
RANDLEISTE, OVAL

DŁUGOŚĆ [m]  
Length | Länge

1,0	2,0	2,5	3,0
-----	-----	-----	-----

	A
	8
A53	10
	12

AI  
ANODA  
+  
-



A53

LISTWA FUGOWA

JOINT STRIP  
FUGENLEISTE

DŁUGOŚĆ [m]  
Length | Länge

1,0	2,0	2,5	3,0
-----	-----	-----	-----

	A
A54	13
A55	18
A56	26

AI  
ANODA  
+



A54-56

LISTWA ŁĄCZENIOWA PŁASKA

FLAT JOINING STRIP  
ÜBERGANGSLEISTE, FLACH

DŁUGOŚĆ [m]  
Length | Länge

1,0	2,0	2,5	3,0
-----	-----	-----	-----

AI  
ANODA



A57

LISTWA SCHODOWA

A58



STAIR STRIP  
STUFENLEISTE

DŁUGOŚĆ [m]  
Length | Länge

1,0

2,0

2,5

3,0

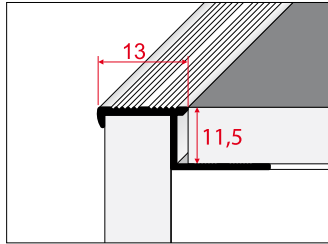

LISTWA NAJAZDOWA

A59



APPROACHING STRIP  
AUSGLEICHLEISTE

DŁUGOŚĆ [m]  
Length | Länge

1,0

2,0

2,5

3,0

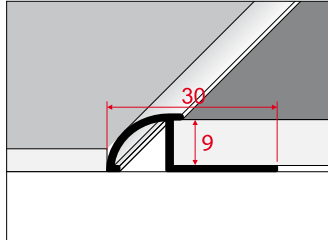

LISTWA SCHODOWA PÓŁOKRĄGŁA

A80



HALF-ROUNDED STAIR STRIP  
STUFENLEISTE

DŁUGOŚĆ [m]  
Length | Länge

1,0

2,0

2,5

3,0

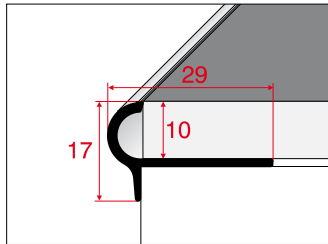

LISTWA SCHODOWA OWALNA

A81



OVAL STAIR STRIP  
STUFENLEISTE

DŁUGOŚĆ [m]  
Length | Länge

1,0

2,0

2,5

3,0

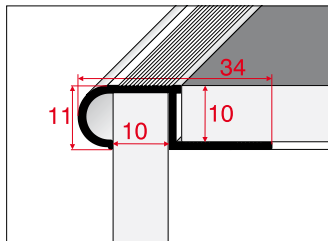

LISTWA DEKORACYJNA RIO

DECORATIVE STRIP RIO  
ZIERLEISTE RIO

DŁUGOŚĆ [m]  
Length | Länge **2,7**

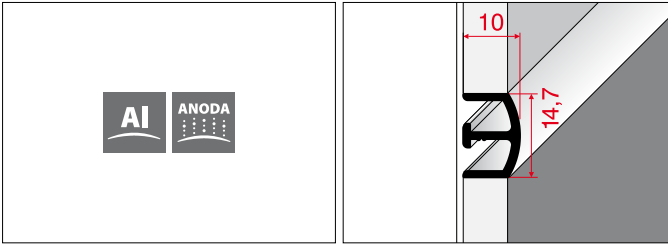

A82

LISTWA DO GLAZURY Z ZAKOŃCZENIAMI ZEWNĘTRZNYMI I WEWNĘTRZNYMI

TILE STRIP WITH EXTERNAL AND INTERNAL CORNER ELEMENTS  
FLIESENLEISTE MIT INNEN UND AUSSENECKEN

DŁUGOŚĆ [m]  
Length | Länge **2,5**

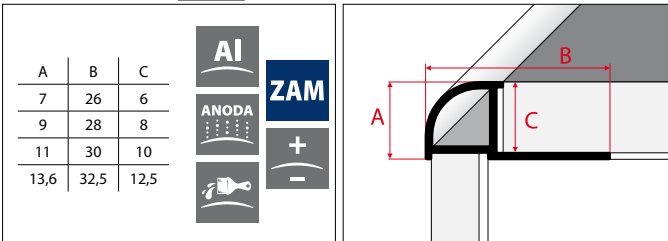

A83

ZAKOŃCZENIA ZEWNĘTRZNE I WEWNĘTRZNE DO LISTWY A83

EXTERNAL AND INTERNAL CORNER ELEMENTS  
INNEN UND AUSSEN ABSCHLUSS PASSEND ZUR LEISTE A83

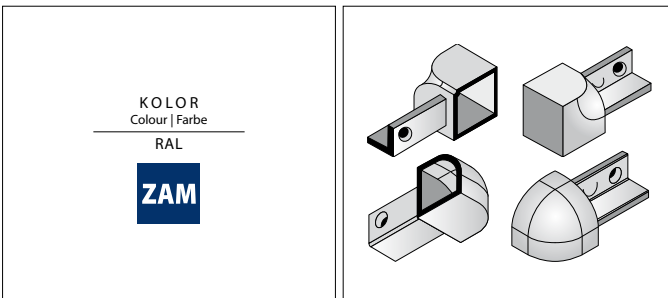

A83

LISTWA DEKORACYJNY RIO

DECORATIVE STRIP RIO  
ZIERLEISTE RIO

DŁUGOŚĆ [m]  
Length | Länge **2,7**

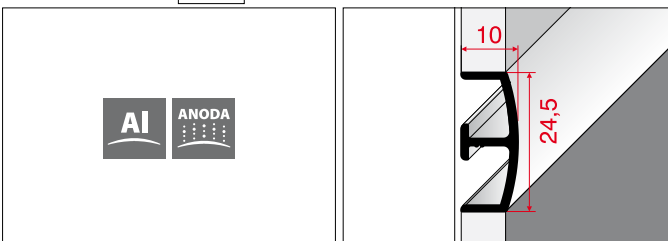

A84

LISTWA SCHODOWA DO GLAZURY

A85



STAIR STRIP FOR TILES  
STUFENLEISTE FÜR KERAMIKFLIESEN

DŁUGOŚĆ [m]  
Length | Länge

1,0

2,0

2,5

3,0

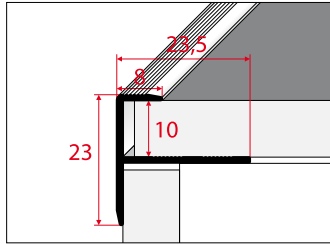

LISTWA ZAKOŃCZENIOWA

A86



ENDING STRIP  
ABSCHLUSSLEISTE

DŁUGOŚĆ [m]  
Length | Länge

2,5

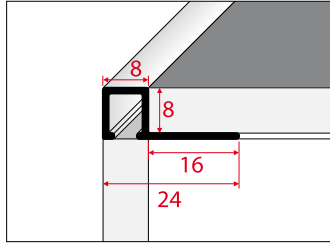

LISTWA ZAKOŃCZENIOWA

A87



ENDING STRIP  
ABSCHLUSSLEISTE

DŁUGOŚĆ [m]  
Length | Länge

2,5

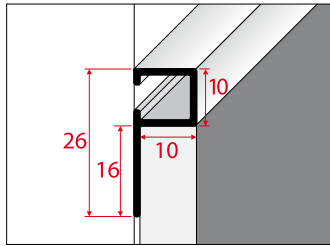

LISTWA ZAKOŃCZENIOWA

A88



ENDING STRIP  
ABSCHLUSSLEISTE

DŁUGOŚĆ [m]  
Length | Länge

2,5

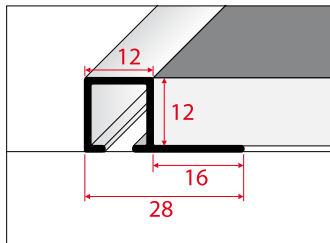



LISTWA WEWNĘTRZNA

INNER STRIP  
INNENLEISTE

DŁUGOŚĆ [m]  
Length | Länge

1,0	2,0	2,5	3,0
-----	-----	-----	-----

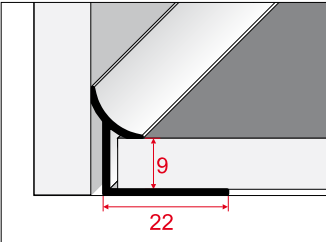

A96

LISTWA NAROŻNA SCHODOWA Z GUMĄ



STAIR STRIP WITH ANTI-SLIP LINING RUBBER  
ECKLEISTE FÜR TREPPEN MIT GUMMIBAND

DŁUGOŚĆ [m]  
Length | Länge

2,5



KOLORY GUMY A98  
RUBBER COLOURS | FARBEN

		
88 CZARNY BLACK SCHWARZ	86 BRAZ BROWN BRAUN	89 SZARY GREY GRAU

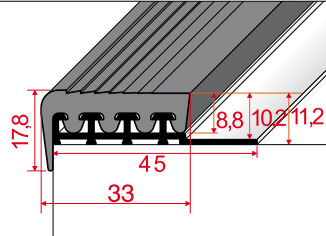



A97  
+A98

LISTWA OKAPOWA

HOOD STRIP  
WETTERSCHENKEL

DŁUGOŚĆ [m]  
Length | Länge

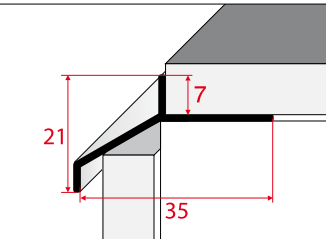
2,5

A99

LISTWA DYLATACYJNA Z WKŁADKĄ EPDM

EXPANSION STRIP WITH EPDM INSERT  
AUSGLEICHSLEISTE MIT EPDM EINSATZ

DŁUGOŚĆ [m]  
Length | Länge



2,5

	A103	A104	A105	A106
A	6	8	10	12,5



KOLOR  
Colour | Farbe

SREBRO  
SILVER | SILBER

	
KOLOR EPDM EPDM COLOUR   FARBEN	SZARY GREY   GRAU

Minimalne zam. 10 szt.  
MOQ 10pcs  
Mindestbestellmenge 10 St.

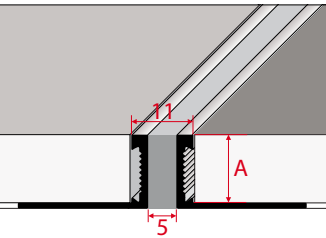

A103-  
106

# KOLORY P53, P96

COLOURS | FARBEN



## LISTWA ZAKOŃCZENIOWA ZEWNĘTRZNA

P53



EDGE STRIP  
RANDLEISTE

DŁUGOŚĆ [m]  
Length | Länge **2,5**

Pakowane po 25 szt.  
Packed by 25 pcs.  
Verpackungseinheit 25 Stck.

A
7
8
9
10

**P53**

**PVC**

## LISTWA ZAKOŃCZENIOWA WEWNĘTRZNA

P96



INNER STRIP  
INNENLEISTE

DŁUGOŚĆ [m]  
Length | Länge **2,5**

Pakowane po 25 szt.  
Packed by 25 pcs.  
Verpackungseinheit 25 Stck.

A
7
8
9
10

**P96**

**PVC**

LISTWA WANNOWA SAMOPRZYLEPNA Z AKCESORIAMI

BATH STRIP SELF-ADHESIVE WITH ACCESSORIES  
DAS LEISTE ZUR BADENWANNE MIT ZUBEHÖREN SELBSTKLEBEND

DŁUGOŚĆ [m]  
Length | Länge **1,83**

KOLOR  
Colour | Farbe **8000**

Akcesoria: 2 x Narożnik wewnętrzny, zakończenie prawe i lewe  
Accessories: 2 x internal corner profile, right and left ending  
Zubehör: 2 x Innenecke, 2 x Endstuecke

Pakowana po 22 szt.  
Packed by 22 pcs.  
Verpackungseinheit 22 Stck.

**PVC**

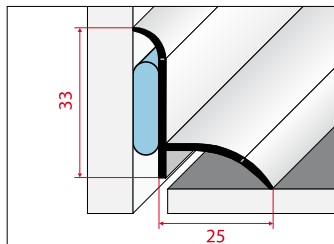

P56

KOLORYSTYKA P61

P61 - COLOURING | P61 - FARBE

<b>701</b> BIAŁY WHITE WEISS	<b>702</b> BIAŁY MARM. WHITE MARBLED WEISS MARMOR	<b>703</b> BUK JASNY LIGHT BEECH BUCHE HELL	<b>704</b> DĄB JASNY LIGHT OAK EICHE HELL	<b>705</b> BEŻOWY BEIGE BEIGE
<b>707</b> ORZECH NUT NUSS	<b>709</b> WENGE WENGE WENGE	<b>801</b> SREBRNY BŁYSK SHINING SILVER SILBER BLITZ	<b>802</b> SREBRNY MAT MATT SILVER SILBER MATT	<b>8800</b> CZARNY BLACK SCHWARZ

LISTWA PRZYBLATOWA

WORKTOP STRIP  
LEISTEN FÜR ARBEITSPLATTEN

DŁUGOŚĆ [m]  
Length | Länge **3,0**

Pakowana po 20 szt.  
Packed by 20 pcs.  
Verpackungseinheit 20 Stck.

**PVC**

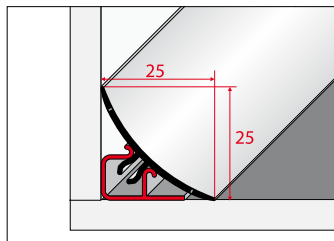

P61

ZAKOŃCZENIE PRAWIE LUB LEWE

RIGHT OR LEFT ENDING PROFILE  
ENDSTÜCK LINKS ODER RECHTS



Pakowane po 30 szt.  
Packed by 30 pcs.  
Verpackungseinheit 30 Stck.

**PVC**

NAROŻNIK WEWNĘTRZNY

INTERNAL CORNER PROFILE  
INNENECKE



Pakowane po 30 szt.  
Packed by 30 pcs.  
Verpackungseinheit 30 Stck.

**PVC**

# Listwy ze **stali** nierdzewnej —



**Stainless  
steel  
strips**



# STEEL



**BEZPIECZEŃSTWO**  
SAFETY



**TRWAŁOŚĆ**  
DURABILITY



**ELEGANCJA**  
ELEGANCE



**NOWOCZESNY  
DESIGN**  
MODERN DESIGN



**EKSPRESOWY  
MONTAŻ**  
QUICK MOUNT



**PRODUKT POLSKI**  
POLISH PRODUCT



**ODPORNOŚĆ  
NA ZARYSOWANIA**  
SCRATCH RESISTANT



**PRZYJAZNE  
ŚRODOWISKU**  
ECO-FRIENDLY



**BEZ ZAWARTOŚCI  
OŁOWIU**  
LEAD FREE

# STAL NIERDZEWNA

STAINLESS STEEL | EDELSTAHL



**P** POLEROWANA  
POLISHED  
POLIERT



**S** SZCZOTKOWANA  
BRUSHED  
GEBÜRSTET

## LISTWA KRAWĘDZIOWA

N01-03



EDGE STRIP  
RANDLEISTE

DŁUGOŚĆ [m]  
Length | Länge **2,5**

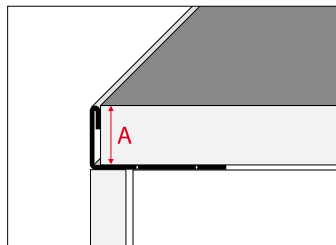

S		KOLOR Colour   Farbe	P, S
			A
N01			8
N02			10
N03			12,5

## LISTWA OWALNA

N04-06



OVAL STRIP  
OVALES LEISTE

DŁUGOŚĆ [m]  
Length | Länge **2,5**

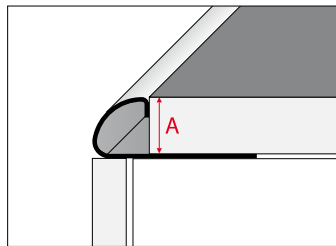

S		KOLOR Colour   Farbe	P, S
			A
N04			8
N05			10
N06			12,5

## ZAKOŃCZENIA ZEWNĘTRZNE I WEWNĘTRZNE DO LISTWY N04-06



NZZ  
04-06



NZW  
04-06

EXTERNAL AND INTERNAL CORNER ELEMENTS  
INNEN UND AUSSEN ABSCHLUSS PASSEND ZUR LEISTE N04-06

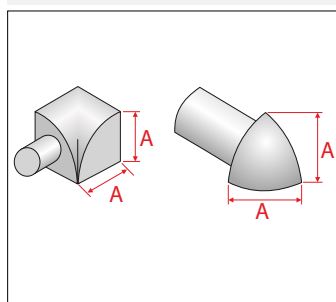

S		KOLOR Colour   Farbe	P, S
			A
NZZ04	NZW04		8
NZZ05	NZW05		10
NZZ06	NZW06		12,5



LISTWA ZAKOŃCZENIOWY

ENDING STRIP  
ABSCHLUSSLEISTE

DŁUGOŚĆ [m]  
Length | Länge **2,5**

<b>S</b>	KOLOR Colour   Farbe		P, S
		A	
	<b>N07</b>	9	
	<b>N08</b>	11	
	<b>N09</b>	12,5	

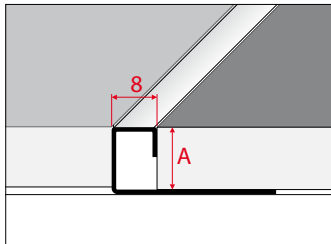

N07-09

ZAKOŃCZENIE DO LISTWY N07-09

CORNER ELEMENTS  
ABSCHLUSS PASSEND ZUR LEISTE N07-09

<b>S</b>	KOLOR Colour   Farbe		P, S
		A	
	<b>NZ07</b>	9	
	<b>NZ08</b>	11	
	<b>NZ09</b>	12,5	

**ZAM**

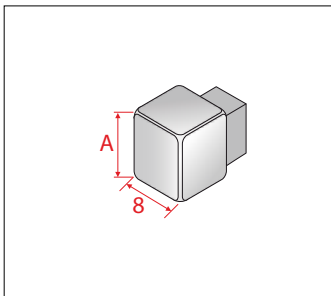

NZ07-09

LISTWA ZAKOŃCZENIOWA

ENDING STRIP  
ABSCHLUSSLEISTE

DŁUGOŚĆ [m]  
Length | Länge **2,5**

<b>S</b>	KOLOR Colour   Farbe		P, S	
		A		B
	<b>N10</b>	9		9
	<b>N11</b>	11		11
	<b>N12</b>	12,5		12,5

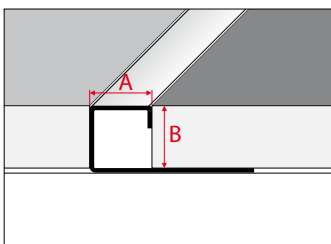

N10-12

ZAKOŃCZENIE DO LISTWY N10-12

CORNER ELEMENTS  
ABSCHLUSS PASSEND ZUR LEISTE N10-12

<b>S</b>	KOLOR Colour   Farbe		P, S	
		A		B
	<b>NZ10</b>	9		9
	<b>NZ11</b>	11		11
	<b>NZ12</b>	12,5		12,5

**ZAM**

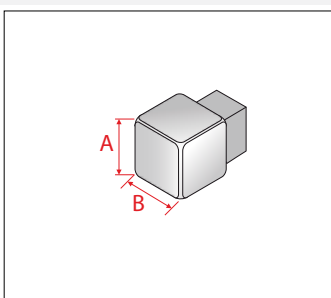

NZ10-12

LISTWA FUGOWA

N13-14



JOINT STRIP  
FUGENLEISTE

DŁUGOŚĆ [m]  
Length | Länge **2,5**

**S** KOLOR Colour | Farbe | P, S

	A
<b>N13</b>	14
<b>N14</b>	25

8 ÷ 8,6

A

LISTWA DEKORACYJNA

N15-16



DECORATIVE STRIP  
ZIERLEISTE

DŁUGOŚĆ [m]  
Length | Länge **2,5**

**S** KOLOR Colour | Farbe | P, S

	A
<b>N15</b>	25
<b>N16</b>	40

6

A

KĄTOWNIK

N17-19



ANGLE BAR  
L PROFIL

DŁUGOŚĆ [m]  
Length | Länge **2,5**

**S** KOLOR Colour | Farbe | P, S

	A
<b>N17</b>	25
<b>N18</b>	30
<b>N19</b>	40

A

A

LISTWA DYLATACYJNA STALOWA Z WKŁADKĄ EPDM

N103-106



STAINLESS STEEL EXPANSION STRIP WITH EPDM INSERT  
EDELSTAHLAUSGLEICHSLEISTE MIT EPDM EINSATZ

DŁUGOŚĆ [m]  
Length | Länge **2,5**

	<b>N103</b>	<b>N104</b>	<b>N105</b>	<b>N106</b>
A	6	8	10	12,5

**S** KOLOR EPDM EPDM COLOUR | FARBEN | SZARY GREY | GRAU

Minimalne zam. 10 szt.  
MOQ 10pcs  
Mindestbestellmenge 10 St.

9,6

6

A





A modern living room interior featuring a vibrant blue sectional sofa with a large, textured grey cushion. In the foreground, a round, light-colored ottoman with a gold-colored metal base sits on a highly reflective glass coffee table. The floor is made of light-colored wood-look planks. The background includes a large window with a view of a beach and ocean, and a side table with decorative vases and books. The overall aesthetic is clean, contemporary, and sophisticated.

**Listwy  
wykończeniowe gięte**

# Bendable finishing strips

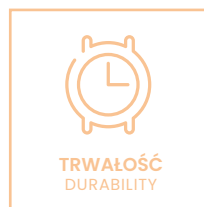

# ALUMINIUM ANODOWANE

ANODISED ALUMINIUM | ALUMINIUM ELOXIERT



01

**SREBRO**  
SILVER  
SILBER



71

**INOX GŁADKI**  
INOX SMOOTH  
INOX GLATT



00

**ZŁOTO**  
GOLD  
GOLD



02

**SZAMPAN**  
CHAMPAGNE  
CHAMPAGNE



005

**CZARNY**  
BLACK  
SCHWARZ

# ALUMINIUM NATURALNE

NATURAL ALUMINIUM | NATUR ALUMINIUM

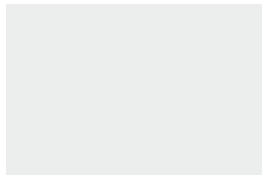

90

**NATURALNE**  
NATURAL  
NATUR

# ALUMINIUM OKLEINOWANE

VENEERED ALUMINIUM | ALUMINIUM UMMANTELT



28

**BUK JASNY**  
LIGHT BEECH  
BUCHE HELL



08

**BUK**  
BEECH  
BUCHE



20916

**DĄB BIAŁY**  
RAW OAK  
EICHE WEIB



20901

**DĄB BIELONY**  
WHITE OAK  
EICHE GEBLEICHT



20918

**DĄB BERGERAC**  
BERGERAC OAK  
EICHE BERGERAC



20917

**DĄB JAŚMINOWY**  
JASMINE OAK  
EICHE JASMIN



20915

**DĄB WANILIA**  
VANILLA OAK  
EICHE VANILLE



20913

**DĄB MALAGA**  
MALAGA OAK  
EICHE MALAGA



20919

**DĄB SZARY**  
GRAY OAK  
EICHE GRAUE



20902

**DĄB MOCCA**  
MOCCA OAK  
EICHE MOCCA



20912

**DĄB TABACCO**  
TABACCO OAK  
EICHE TABACCO



20904

**DĄB ARCTIC**  
ARCTIC OAK  
EICHE ARCTIC

# ALUMINIUM OKLEINOWANE

VENEERED ALUMINIUM | ALUMINIUM UMMANTELT



**20930** DĄB HELSINKI  
OAK HELSINKI  
HELSINKI-EICHE



**20927** DĄB TOKIO  
OAK TOKYO  
TOKIO-EICHE



**20926** DĄB NAIROBI  
OAK NAIROBI  
NAIROBI-EICHE



**20929** DĄB OSLO  
OAK OSLO  
OSLO-EICHE



**20928** DĄB RIO  
OAK RIO  
RIO-EICHE



**20920** DĄB NATURALNY  
NATURAL OAK  
EICHE NATUR



**20921** DĄB LEMON  
LEMON OAK  
EICHE LEMON



**20908** DĄB PIWNY  
BEER OAK  
EICHE HELLBRAUN



**29** DĄB JASNY  
LIGHT OAK  
EICHE HELL



**20907** DĄB PIASKOWY  
SANDY OAK  
EICHE SAND



**20906** DĄB KONIAKOWY  
COGNAC OAK  
EICHE COGNAC



**20905** DĄB BURSZTYNOWY  
AMBER OAK  
EICHE BERNSTEIN



**20903** DĄB ANTYCZNY  
ANTIQUO OAK  
EICHE ANTIK



**20914** DĄB TOPAZ  
TOPAZ OAK  
EICHE TOPAS



**20911** DĄB VERDEN  
VERDEN OAK  
EICHE VERDEN



**20910** DĄB ZAMKOWY  
CASTLE OAK  
SCHLOSS EICHE



**0909** DĄB ŻŁOCISTY  
GOLDEN OAK  
EICHE GOLD



**09** DĄB  
OAK  
EICHE



**34** WIĄZ  
ELM  
ULME



**32** HIKORA  
HICKORY  
HIKORYBAUM



**20922** ORZECH SIENNA  
SIENA NUT  
SIENNE NUSS



**2701** ORZECH CHILE  
CHILE NUT  
NUSSBAUM CHILE



**20944** MERBAU  
MERBAU  
MERBAU



**4500** TEAK INDYJSKI  
INDIAN TEAK  
INDISCHER TEAK



**33** AFREZJA  
AFREZY  
AFREZY



**3101** KASZTAN JAPONSKI  
JAPANESE CHESTNUT  
JAPANISCHE KASTANIE



**4201** WENGE KONGO  
CONGO WENGE  
WENGE KONGO

LISTWA NAROŻNA GIĘTA

S53



BENDABLE CORNER STRIP  
ECKLEISTE GEBOGEN

DŁUGOŚĆ [m]  
Length | Länge **2,5**

LISTWA ŁĄCZENIOWA GIĘTA

S57



BENDABLE JOINING STRIP  
VERBINDUNGSPLEISTE BIEGSAM

DŁUGOŚĆ [m]  
Length | Länge **2,5**

LISTWA ŁĄCZENIOWA GIĘTA

S92



BENDABLE JOINING STRIP  
VERBINDUNGSPLEISTE BIEGSAM

DŁUGOŚĆ [m]  
Length | Länge **2,5**

LISTWA ZAKOŃCZENIOWA GIĘTA

S93



BENDABLE FINISHING STRIP  
ABSCHLUSSLEISTE BIEGSAM

DŁUGOŚĆ [m]  
Length | Länge **2,5**

LISTWA NAROŻNA GIĘTA

BENDABLE CORNER STRIP  
ECKLEISTE GEBOGEN

DŁUGOŚĆ [m]  
Length | Länge **3,0**

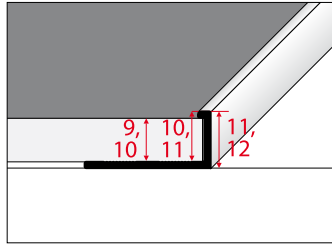

**S94**



# Kształtowniki dla **majsterkowiczów**

DIY profiles



# EASY



**BEZPIECZEŃSTWO**  
SAFETY



**TRWAŁOŚĆ**  
DURABILITY



**ELEGANCJA**  
ELEGANCE



**PRODUKT POLSKI**  
POLISH PRODUCT



**NOWOCZESNY  
DESIGN**  
MODERN DESIGN



**EKSPRESOWY  
MONTAŻ**  
QUICK MOUNT



**ODPORNOŚĆ  
NA ZARYSOWANIA**  
SCRATCH RESISTANT



**PRZYJAZNE  
ŚRODOWISKU**  
ECO-FRIENDLY



**BEZ ZAWARTOŚCI  
OŁOWIU**  
LEAD FREE

# ALUMINIUM ANODOWANE

ANODISED ALUMINIUM | ALUMINIUM ELOXIERT



01

**SREBRO**  
SILVER  
SILBER



71

**INOX GŁADKI**  
INOX SMOOTH  
INOX GLATT



07

**INOX SZCZOTKOWANY**  
BRUSHED INOX  
GEBÜRSTET INOX



00

**ZŁOTO**  
GOLD  
GOLD



005

**CZARNY**  
BLACK  
SCHWARZ

# ALUMINIUM NATURALNE

NATURAL ALUMINIUM | NATUR ALUMINIUM

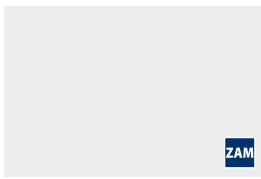

90

**NATURALNE**  
NATURAL  
NATUR

# ALUMINIUM LAKIEROWANE

LACQUERED ALUMINIUM | LACKIERTES ALUMINIUM



9016

**BIAŁY**  
WHITE  
WEISS



7016

**GRAFIT**  
GRAPHITE  
GRAPHIT



9005

**CZARNY**  
BLACK  
SCHWARZ

# PROFILE PAKOWANE PO 5 SZT.

PROFILES PACKED BY 5 PIECES. | PROFILE VERPACKT ZU JE 5 STK

## PŁASKOWNIK

B00-05



FLAT SHAPE SECTION  
FLACHLEISTE

DŁUGOŚĆ [m]  
Length | Länge

1,0

2,0

3,0\*

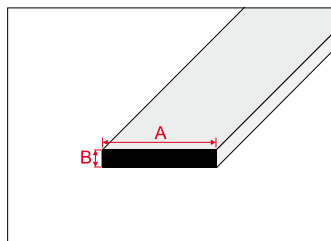

	A	B
<b>B00</b>	15	3
<b>B01</b>	20	3
<b>B02</b>	25	2
<b>B03</b>	25	3
<b>B04</b>	40	3
<b>B05</b>	50	2



\*

KĄTOWNIK RÓWNORAMIENNY

EQUAL-SIDED ANGLE BAR  
WINKELPROFIL, GLEICHSCHENKLIG

DŁUGOŚĆ [m]  
Length | Länge

1,0

2,0

3,0\*

	A	B	C
<b>B10</b>	20	20	2
<b>B11</b>	25	25	2
<b>B12</b>	15	15	1,5
<b>B13</b>	12	12	2
<b>B14</b>	30	30	2
<b>B15</b>	35	35	2
<b>B16</b>	40	40	2
<b>B17</b>	50	50	2

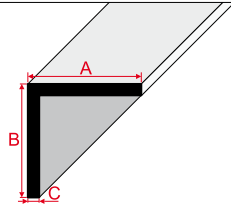

B10-17

KĄTOWNIK NIERÓWNORAMIENNY

NON-EQUAL SIDED ANGLE BAR  
WINKELPROFIL, NICHT GLEICHSCHENKLIG

DŁUGOŚĆ [m]  
Length | Länge

1,0

2,0

3,0\*

	A	B	C
<b>B20</b>	40	20	2
<b>B21</b>	30	20	2
<b>B22</b>	25	20	2
<b>B23</b>	20	10	2

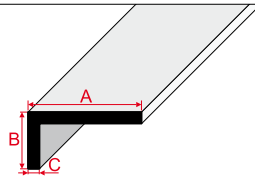

B20-23

KĄTOWNIK FAZOWANY

CHAMFERED ANGLE BAR  
WINKELPROFIL, GEFAST

DŁUGOŚĆ [m]  
Length | Länge

1,0

2,0

3,0\*

	A	B	C
<b>B24</b>	20	8	1,5
<b>B25</b>	14	10	1,5

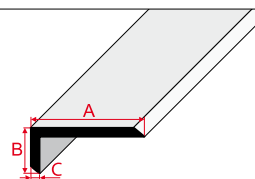

B24-25

CEOWNIK

CHANNEL BAR  
U-PROFIL

DŁUGOŚĆ [m]  
Length | Länge

1,0

2,0

3,0\*

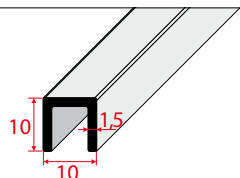

B30

## CEOWNIK NIERÓWNORAMIENNY

B31



NON-EQUAL SIDED CHANNEL BAR  
U-PROFIL, NICHT GLEICHSCHENKLIG

DŁUGOŚĆ [m]  
Length | Länge

1,0

2,0

3,0\*

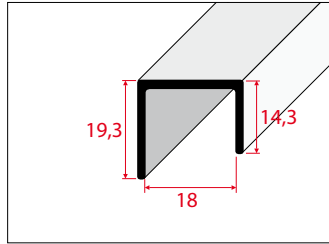

## RURA

B40-45



TUBE  
RUNDROHR

DŁUGOŚĆ [m]  
Length | Länge

1,0

2,0

3,0\*

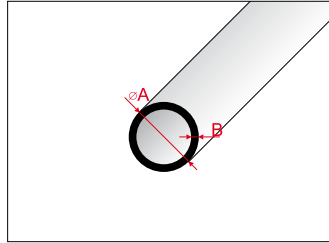

	A	B
<b>B40</b>	5	1
<b>B41</b>	8	1
<b>B42</b>	10	1
<b>B43</b>	12	1
<b>B45</b>	20	1,5



## RURA PROSTOKĄTNA

B50  
B52



RECTANGULAR TUBE  
ROHR, RECHTECKIG

DŁUGOŚĆ [m]  
Length | Länge

1,0

2,0

3,0\*

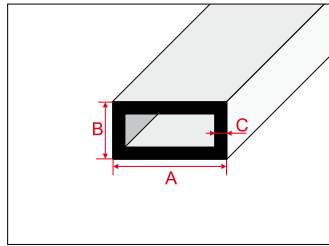

	A	B	C
<b>B50</b>	12	10	1
<b>B52</b>	20	10	2



## RURA KWADRATOWA

B53-55

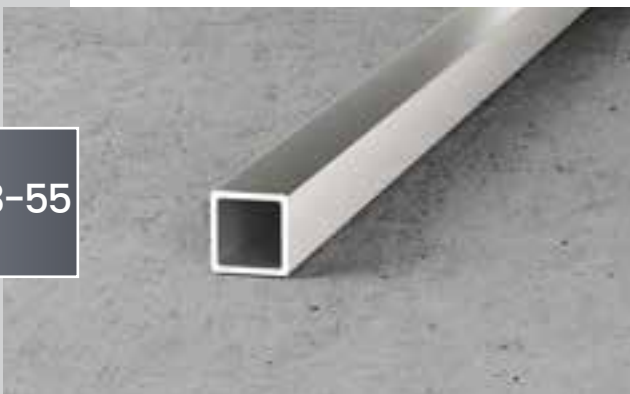

SQUARE TUBE  
4KT ROHR

DŁUGOŚĆ [m]  
Length | Länge

1,0

2,0

3,0\*

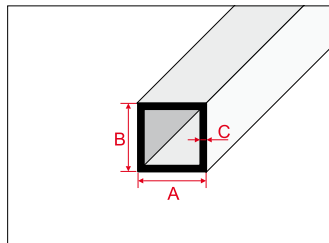

	A	B	C
<b>B53</b>	12	12	1
<b>B54</b>	15	15	1
<b>B55</b>	20	20	1



CEOWNIK RYFLOWANY

RIFFLED CHANNEL BAR  
U-PROFIL, GERIFFELT

DŁUGOŚĆ [m]  
Length | Länge

1,0

2,0

3,0 \*

	A	B	C	D
<b>B60</b>	10	10,9	8,5	7,5
<b>B61</b>	10	12,9	10,5	9,5
<b>B62</b>	10	16,1	13,5	12,5
<b>B63</b>	21	21,1	18,5	17,5

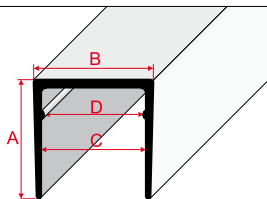

B60-63

CEOWNIK

CHANNEL BAR  
U-PROFIL

DŁUGOŚĆ [m]  
Length | Länge

1,0

2,0

3,0 \*

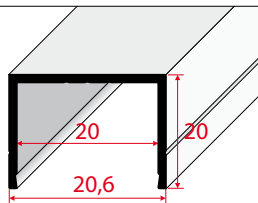

B81

TEOWNIK

T-BAR  
T-PROFIL

DŁUGOŚĆ [m]  
Length | Länge

1,0

2,0

3,0 \*

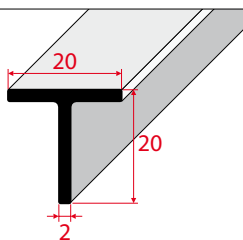

B90

HAOWNIK

H-BAR  
H-PROFIL

DŁUGOŚĆ [m]  
Length | Länge

1,0

2,0

3,0 \*

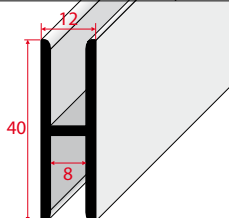

B91

# ALUMINIUM ANODOWANE

ANODISED ALUMINIUM | ALUMINIUM ELOXIERT



**01** SREBRO  
SILVER  
SILBER



**00** ZŁOTO  
GOLD  
GOLD



**02** SZAMPAN  
CHAMPAGNE  
CHAMPAGNE

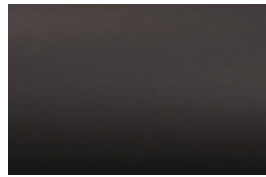

**03** BRAŹ  
BROWN  
BRAUN

# ALUMINIUM LAKIEROWANE

LACQUERED ALUMINIUM | LACKIERTES ALUMINIUM



**9016** BIAŁY  
WHITE  
WEISS



**081** BEŻ  
BEIGE  
BEIGE



**080** BUKOWY  
BEECH  
BUCHENHOLZ



**082** BRAŹ  
BROWN  
BRAUN



PROFIL ZAKOŃCZENIOWY PRAWY

RIGHT ENDING PROFILE  
ABSCHLUSSLEISTE, RECHTS

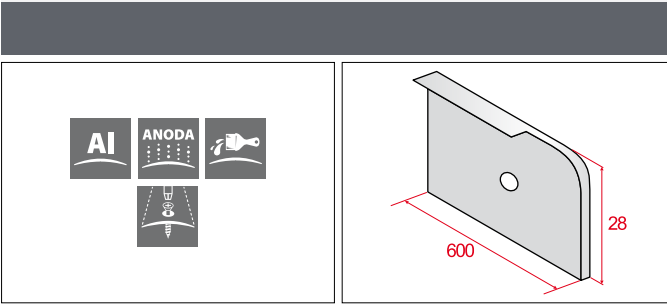

K01

PROFIL ZAKOŃCZENIOWY LEWY

LEFT ENDING PROFILE  
ABSCHLUSSLEISTE, LINKS

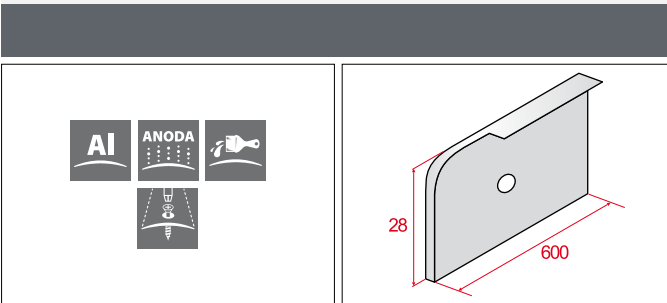

K02

PROFIL ŁĄCZENIOWY GIĘTY

BOWLED JOINING PROFILE  
VERBINDUNGSLEISTE, ELASTISCH

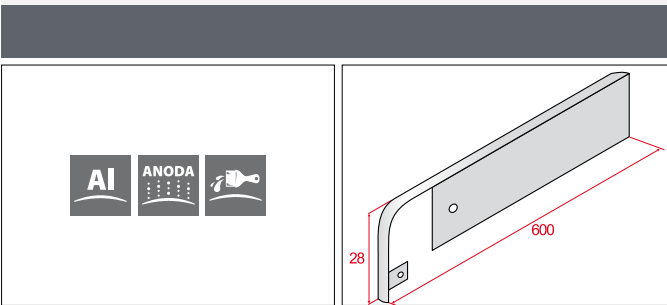

K03

PROFIL ŁĄCZENIOWY

JOINING PROFILE  
VERBINDUNGSLEISTE

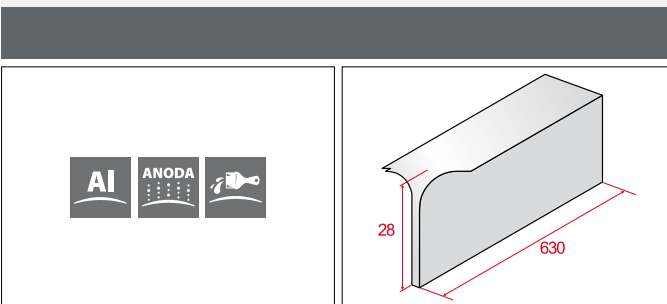

K04



Listwy  
budowlane PVC



# PVC strips

# FANTAZJA



**BEZPIECZEŃSTWO**  
SAFETY



**TRWAŁOŚĆ**  
DURABILITY



**ELEGANCJA**  
ELEGANCE



**BOGATA GAMA  
KOLORYSTYCZNA**  
COLORFUL



**NOWOCZESNY  
DESIGN**  
MODERN DESIGN



**PRODUKT POLSKI**  
POLISH PRODUCT



**EKSPRESOWY  
MONTAŻ**  
QUICK MOUNT



**WYJĄTKOWA  
ELASTYCZNOŚĆ**  
UNIQUE ELASTIC



**PRZYJAZNE  
ŚRODOWISKU**  
ECO-FRIENDLY



**BEZ ZAWARTOŚCI  
OŁOWIU**  
LEAD FREE

# KOLORY

COLOURS | FARBEN

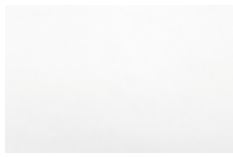

**8000** BIAŁY  
WHITE  
WEISS



**2800** BUK JASNY  
LIGHT BEECH  
BUCHE HELL



**0800** BUK  
BEECH  
BUCHE



**3000** SOSNA  
PINE  
KIEFER



**2300** OLCHA  
ALDER  
ERLE



**2900** DĄB JASNY  
LIGHT OAK  
EICHE HELL



**0901** DĄB CIEMNY  
DARK OAK  
EICHE DUNKEL



**0240** MAHOŃ  
MAHOGANY  
MAHAGONI



**0270** ORZECH  
NUT  
NUSS



**0271** ORZECH  
GRECKI  
GREEK WALNUT  
NUSS GRIECHISCH



**4201** WENGE  
KONGO  
CONGO WENGE  
WENGE KONGO



**20902** DĄB MOCCA  
MOCCA OAK  
EICHE MOCCA



**20904** DĄB ARCTIC  
ARCTIC OAK  
EICHE ARCTIC

## LISTWY PAKOWANE PO 15 SZT.

STRIPS PACKED BY 15 PIECES. | LEISTEN VERPACKT ZU JE 15 STK

### LISTWA BUDOWLANA

F01-04



BUILDING STRIP  
BAULEISTE

DŁUGOŚĆ [m]  
Length | Länge

2,2

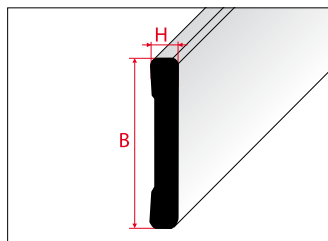

	B	H	KOLOR Colour   Farbe
<b>F01</b>	40	6	8000, 0240, 0270
<b>F02</b>	50	7	8000
<b>F03</b>	60	8	8000
<b>F04</b>	70	9	8000

PVC

LISTWA MASKUJĄCA

MASKING STRIP  
MASKIERLEISTE

DŁUGOŚĆ [m]  
Length | Länge **2,7**

	B	KOLOR Colour   Farbe
<b>F05</b>	30	8000
<b>F06</b>	19	8000

**PVC**

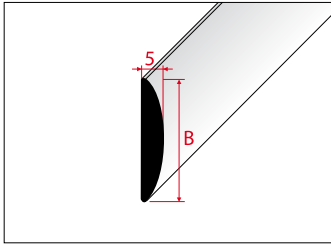

F05-06

ĆWIERĆWAŁEK „13 X 8”

QUADRANT MOULDING  
VIERTELSTAB

DŁUGOŚĆ [m]  
Length | Länge **2,7**

KOLOR Colour   Farbe	8000
<b>PVC</b>	

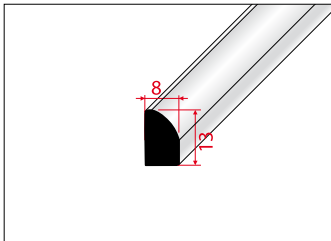

F07

ĆWIERĆWAŁEK „10”; „14”

QUADRANT MOULDING  
VIERTELSTAB

DŁUGOŚĆ [m]  
Length | Länge **2,7**

	H	KOLOR Colour   Farbe
<b>F08</b>	10	8000, 2900, 20904, 20902, 0271
<b>F09</b>	14	8000, 2900, 0240, 0270, 0271, 20902

**PVC**

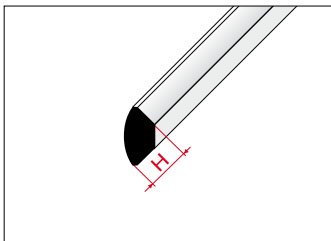

F08-09

NAROŻNIK BUDOWLANY „20”

CORNER STRIP  
ECKLEISTE

DŁUGOŚĆ [m]  
Length | Länge **2,7**

KOLOR Colour   Farbe	8000
<b>PVC</b>	

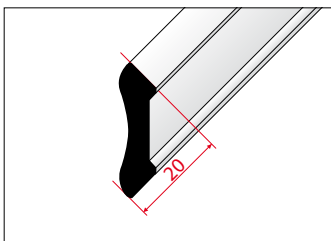

F10

KĄTOWNIK

F14-16  
F19-22



ANGLE BAR  
L PROFIL

DŁUGOŚĆ [m] **2,75**  
Length | Länge

KOLORY JEDNOLITE  
PLAIN COLOURS  
STANDARD FARBEN

<b>8000</b> BIAŁY WHITE WEISS	<b>8800</b> CZARNY BLACK SCHWARZ	<b>8600</b> BRĄZOWY BROWN BRAUN	<b>8901</b> JASNY SZARY LIGHT GREY HELL GRAU

KOLOR Colour   Farbe	F14, F19	8000		
	F15-F16 F20-F21	kolory drewnopodobne plain colours	Wood-like colors plain colours	Holzähnliche Farben Standard Farben
	F22*	kolory drewnopodobne, 8000, 8800	Wood-like colors, 8000, 8800	Holzähnliche Farben, 8000, 8800

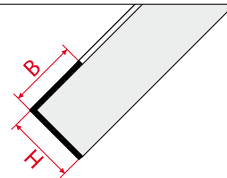

	B	H
<b>F14</b>	15	15
<b>F15</b>	20	20
<b>F16</b>	25	25
<b>F19</b>	10	10
<b>F20</b>	20	10
<b>F21</b>	30	30
<b>F22</b>	40	40

PVC





# EKSPOZYTORY

STANDS | DISPLAYS

## EFFECT 40 TRIO

60 zawieszek | 60 hooks | 60 Anhänger

## EFFECT 60 TRIO

90 zawieszek | 90 hooks | 90 Anhänger

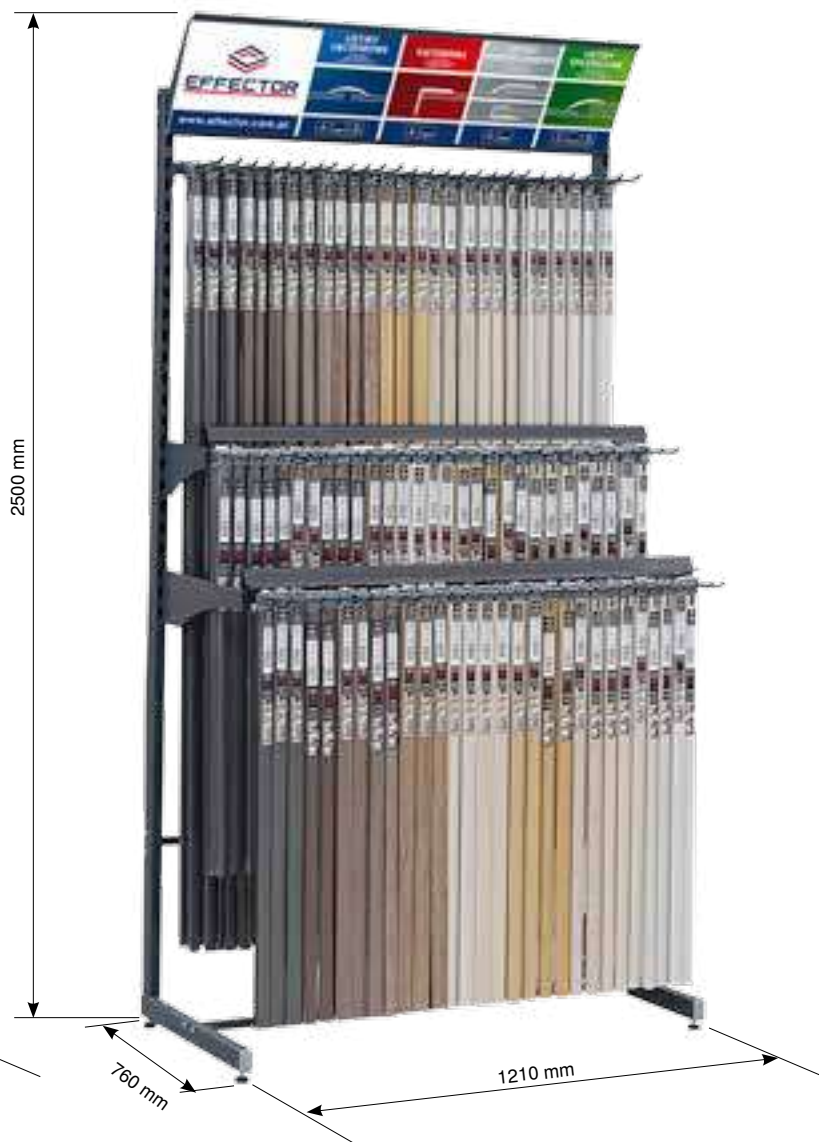
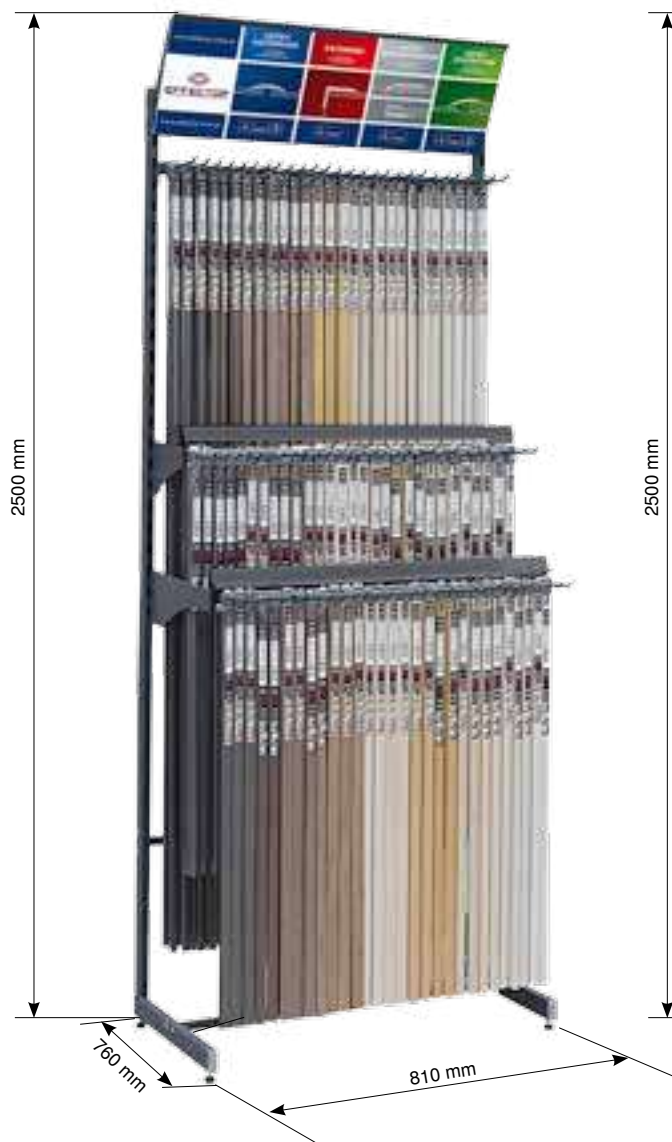

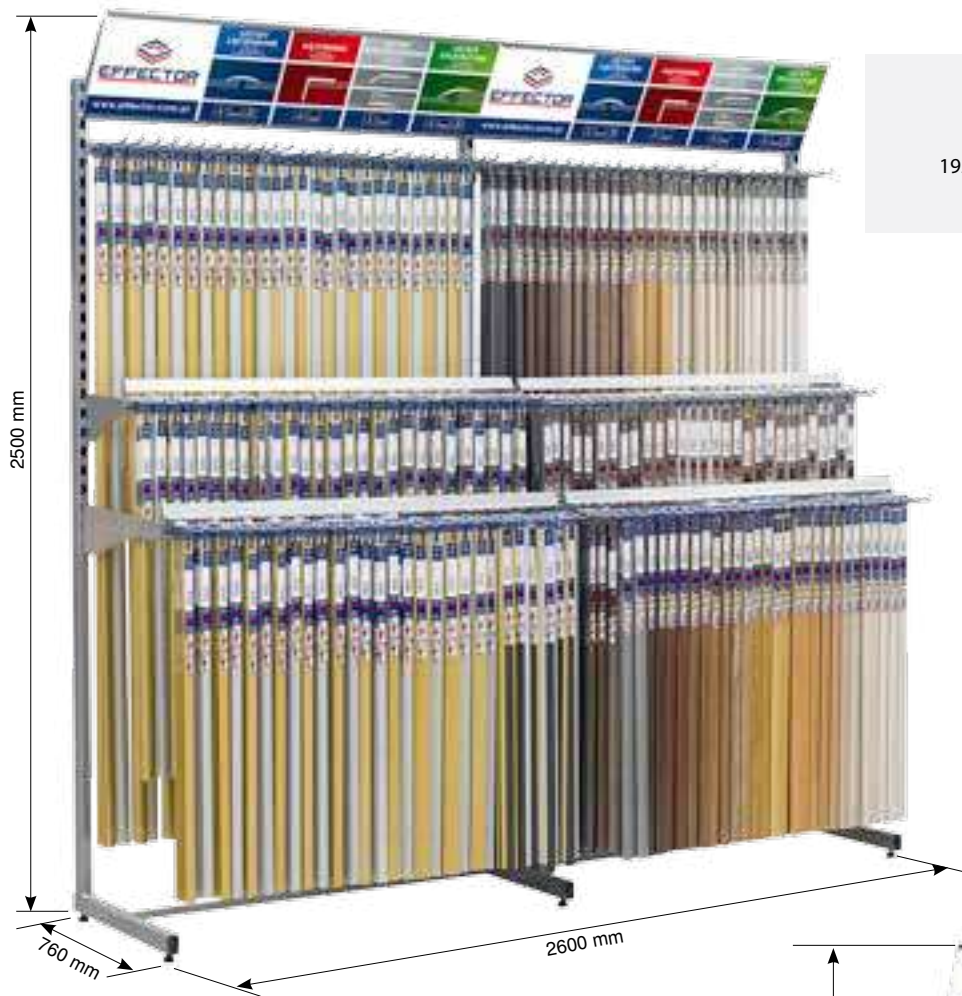

**EFFECT MAGO**  
 192 zawieszek | 192 hooks | 192 Anhänger



**EFFECT STARTMIX**  
 25 przegródek | 25 compartments | 25 Fächer  
 39 zawieszek | 39 hooks | 39 Anhänger

## EFFECT IMPRESJA 80

16 przegródek | 16 compartments | 16 Fächer

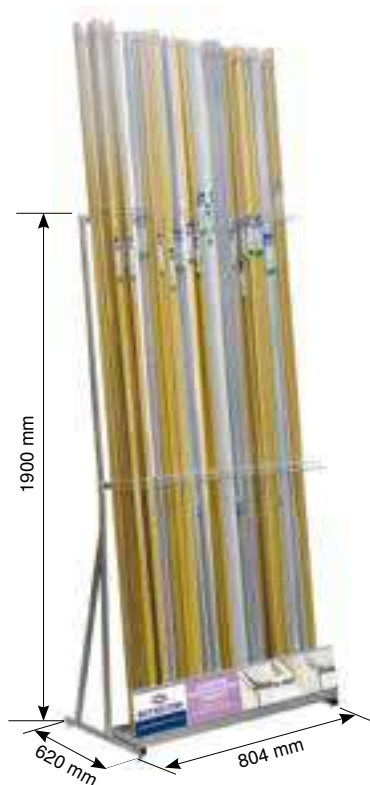

## EFFECT IMPRESJA

25 przegródek | 25 compartments | 25 Fächer



## EFFECT PRAKTIKER

64 przegródek | 64 compartments | 64 Fächer

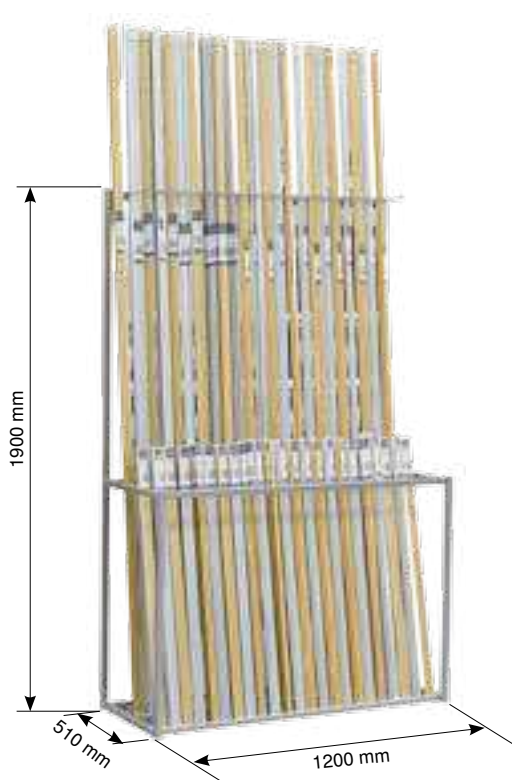

## WIESZAK/HANGER

13 zawieszek | 13 hooks | 13 Anhänger

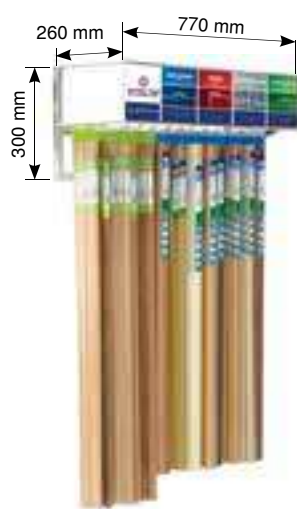

## STOJAK DO LISTEW BLATOWYCH

TABLE TOP PROFILES EXPOSITOR

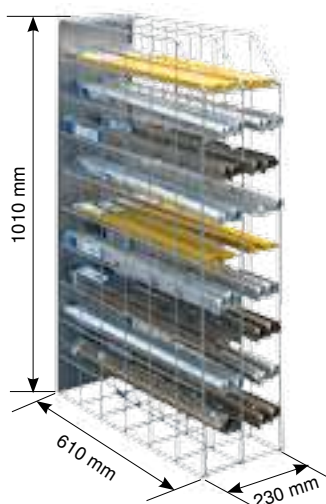

## STOJAK DO LISTEW PRZYBLATOWYCH Z SZUFLADĄ

TABLE TOP PROFILES EXPOSITOR WITH DRAWER

25 przegródek | 25 compartments | 25 Fächer

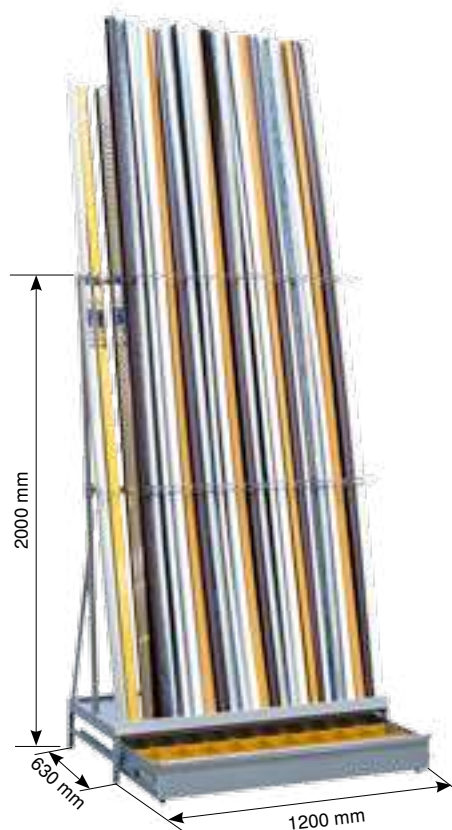



## EFFECT EFFECTA / CLASSIC

17 przegródek | 17 compartments | 17 Fächer

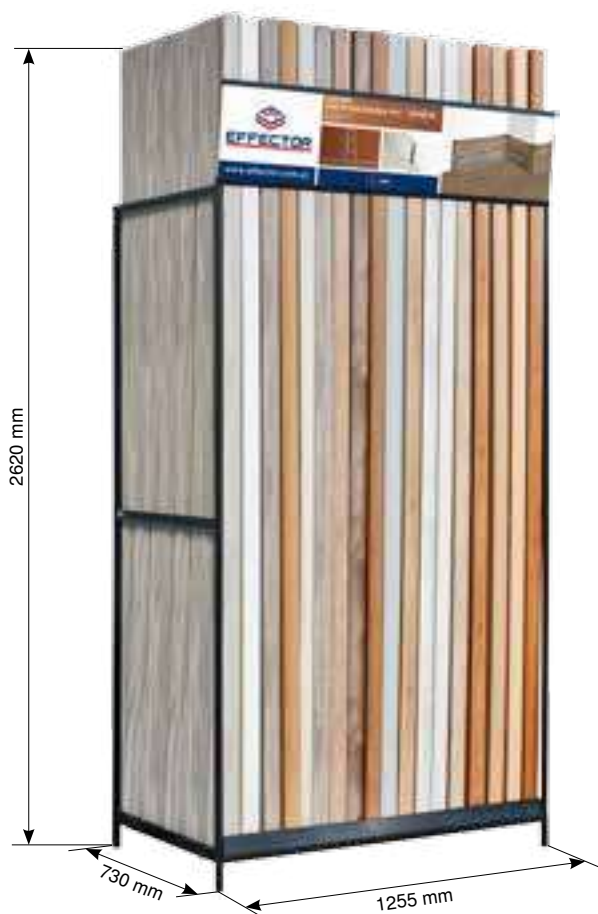

## EFFECT EFFECTA / CLASSIC

Szafki (metalowe) do wykończeń

Metal cabinets for accessories | Metallschränke für Zubehör

	<b>WYMIAR [mm]</b> dimensions   Abmessungen a x b x c	<b>WAGA [kg]</b> weight   Gewicht
<b>10 SZUFLAD - 5X2</b> DRAWERS   SCHUBLADEN	1230 X 455 X 510	50
<b>10 SZUFLAD - 2X5</b> DRAWERS   SCHUBLADEN	510 X 1085 X 510	50
<b>18 SZUFLAD - 6X3</b> DRAWERS   SCHUBLADEN	1280 X 660 X 515	90
<b>20 SZUFLAD - 5X4</b> DRAWERS   SCHUBLADEN	1230 X 880 X 510	100
<b>20 SZUFLAD - 4X5</b> DRAWERS   SCHUBLADEN	990 X 1085 X 510	100
<b>25 SZUFLAD - 5X5</b> DRAWERS   SCHUBLADEN	1230 X 1085 X 510	120
<b>30 SZUFLAD - 5X6</b> DRAWERS   SCHUBLADEN	1230 X 1300 X 510	150



## EFFECT EASY BOX

48 przegródek | 48 compartments | 48 Fächer

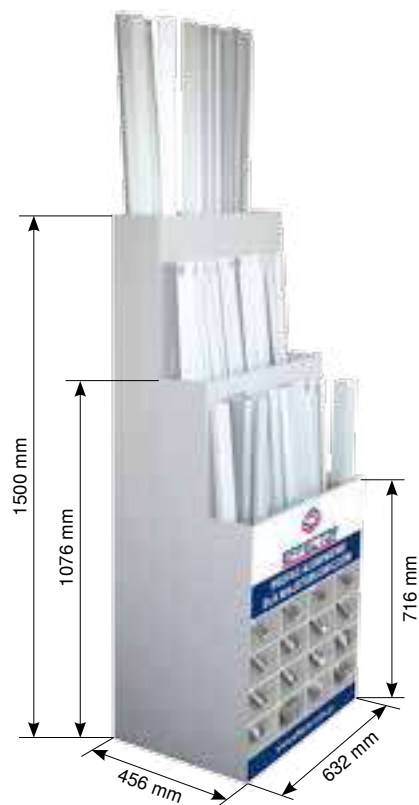

# WZORNIKI

SAMPLE SET | MUSTER



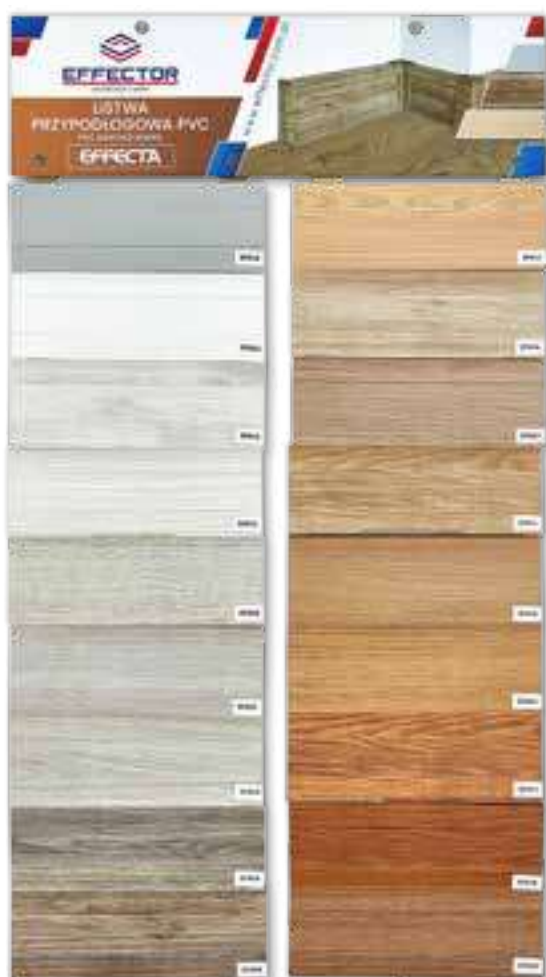

Katalog stanowi informację handlową i nie może być uznawany za ofertę w rozumieniu art. 66 ust. 1 Kodeksu Cywilnego.  
Stanowi on jedynie zaproszenie do rokowań w rozumieniu art. 71 Kodeksu Cywilnego.  
Ze względu na proces technologiczny druku, kolory przedstawionych produktów mogą różnić się od oryginału.



[www.effector.pl](http://www.effector.pl)



**EFFECTOR S.A.**

ul. Hauke-Bosaka 2, 25-214 Kielce

**Zakład Produkcyjny**

29-100 Włoszczowa, ul. Młynarska 29, POLSKA/POLAND

tel. +48 41 39 42 799, fax +48 41 39 45 120

e-mail: [listwy@effector.pl](mailto:listwy@effector.pl)

e-mail: [export@effector.pl](mailto:export@effector.pl)